

# TIMBER TOWER RESEARCH PROJECT

System Report #1  
Gravity Framing Development of  
Concrete Jointed Timber Frame System

May 30<sup>th</sup>, 2014

© Skidmore, Owings, and Merrill, LLP 2014  
224s Michigan Avenue Suite 1000  
Chicago, IL 60604

# Table of Contents

- Acknowledgements ..... 3
- Section 1: Introduction..... 4
  - 1.1: Development of Initial Research Project
  - 1.2: Purpose of Report
  - 1.3: Research Objectives
- Section 2: Gravity Framing System Description ..... 5
  - 2.1: System Description
  - 2.2: Study Geometry
  - 2.3: Structural Component Details
  - 2.4: Gravity System Design Behavior
- Section 3: Design Criteria..... 22
  - 3.1: Load Criteria
  - 3.2: Deflection Criteria
  - 3.3: Strength Criteria
  - 3.4: Vibration Criteria
- Section 4: Analysis Model ..... 23
  - 4.1: Model Description
  - 4.2: Analysis Software
  - 4.3: Analysis Inputs
  - 4.4: Combination of Results
- Section 5: Analysis Results ..... 29
  - 5.1: Data Output Conventions
  - 5.2: Reactions
  - 5.3: Modal Results
  - 5.4: Deformations
  - 5.5: Shear Demands
  - 5.6: Moment Demands
  - 5.7: Torsion and Connection Demands
- Section 6: Design Checks ..... 46
  - 6.1: Deflection Evaluation
  - 6.2: Vibration Evaluation
  - 6.3: Strength Checks
- Section 7: Conclusions ..... 56
  - 7.1: Review of Studies
  - 7.2: Review of System Performance
  - 7.3: Verification of Assumptions

- Appendix 1: Contractor Review Summary ..... 57
  - A1.1: Contractor Review Summary
- Appendix 2: Potential Testing Program..... 58
  - A2.1: Floor Composite Action Test
  - A2.2: Floor Moment Connection Test
  - A2.3: Column Moment Connection Test
  - A2.4: Full Scale System Mockup
  - A2.5: Fire Resistance Testing
- Appendix 3: Additional Connection Details..... 61
- References ..... 71

## Acknowledgments

Funding for this report was provided by the Softwood Lumber Board. The Softwood Lumber Board is an industry funded research, promotion and information program for softwood lumber. The purpose of the program is to strengthen the position of softwood lumber in the marketplace, maintain and expand markets for softwood lumber, and develop new uses for softwood lumber within the United States. The research presented appropriately contains study and analysis designed to advance the desirability, use, and product development of softwood lumber. For more information and to contact the Softwood Lumber Board, refer to the following contact information:

Softwood Lumber Board  
330 N. Wabash Avenue  
Chicago, IL 60611  
Phone: 312-321-5131

[www.softwoodlumberboard.org](http://www.softwoodlumberboard.org)

# Section 1: Introduction

## 1.1 Development of Initial Research Project

The initial research report released by SOM dated May 6<sup>th</sup> 2013 includes recommendations for additional research and physical testing. These recommendations apply to both general mass-timber systems and SOM's proposed "Concrete Jointed Timber Frame" (CJTF) system. This report consists of detailed analysis of the gravity framing components of the overall CJTF system as recommended in the initial report. This portion of the overall system was chosen for additional research first because it represents the majority of materials used in the structure, making it a primary consideration in overall cost and carbon footprint and also involves untested connection detailing not typical of timber construction. The gravity framing system includes the composite mass-timber floor planks, reinforced concrete spandrels, and reinforced concrete joints which connect to the vertical mass-timber elements.

## 1.2 Purpose of Report

The purpose of this report is to provide detailed structural system information and expected behavior that could inform a physical testing program of the gravity framing system.

## 1.3 Report Objectives

The research on the gravity framing system has the following objectives:

- Review design and acceptance criteria for the gravity framing system
- Analyze the gravity system for a general arrangement of vertical bearing elements
- Report the system design behavior (deflections, vibrations, strength requirements)
- Determine potential structural details which could achieve the acceptance criteria

## Section 2: Gravity Framing System Description

### 2.1 System Description

For the purposes of this report, the gravity framing system is defined as the structure which directly supports floor loads. The gravity framing system consists of composite mass-timber planks which primarily span ‘one-way’ between mass-timber shear walls and mass-timber columns. The composite timber planks consist of mass-timber planks such as Cross-Laminated Timber (CLT) with a precast concrete composite topping. The planks are moment connected to the timber walls with a reinforced concrete joint which runs along the length of the wall. The composite timber planks are moment connected to the timber columns with a reinforced concrete beam and joint at the column. Study of the connections of the joints is included in the scope of the report. The columns and walls are included only from the perspective of support stiffness. The layout of the gravity framing system studied is shown in Figures 1-1 to 1-3. This study layout is a general system layout which would be part of the overall floor structure. The applicability of this generalized study layout is highlighted in Figure 1-4.

The system shown in Figures 1-1 to 1-3 differs from that in the original report. The primary change relates to the concrete topping slab which is required to control acoustics. The topping slab required for acoustics has been changed from a non-structural topping to a composite structural topping. The topping slab documented in this report is a 2 inch thick normal weight composite structural topping. It is expected that the mass-timber planks will be ‘pre-topped’, meaning the topping slab is cast on top of the mass-timber planks off-site, or on-site prior to erection. The topping slab is therefore referred to as ‘precast’ in this report. Since the topping slab is now designed to be a structural element, normal weight concrete was chosen over lightweight concrete due to the higher material stiffness. This change to a precast structural composite topping allows for a thinner overall ceiling sandwich, reduced field work, and simplified moment connections. This decision was based in part on a contractor review of the initial system which is summarized in Appendix 1.

Composite flexural behavior between the CLT floor plank and precast concrete topping slab is achieved by providing a horizontal shear connection at the interface of the two materials. This connection must be ductile under ultimate loads yet stiff in service to minimize slip and additional deflections. Several connection types have already been developed and tested to achieve this goal [10]. Shear connection details developed to date have been focused on simply supported floors where the concrete topping slab is in compression. The CJTF system proposed in this report may require additional research and testing related to composite floor behavior due to the negative bending of the floor system which applies tension to the topping slab. New shear connectors which function in cracked concrete may need to be developed as a result. New concepts for shear connectors are provided in this report.

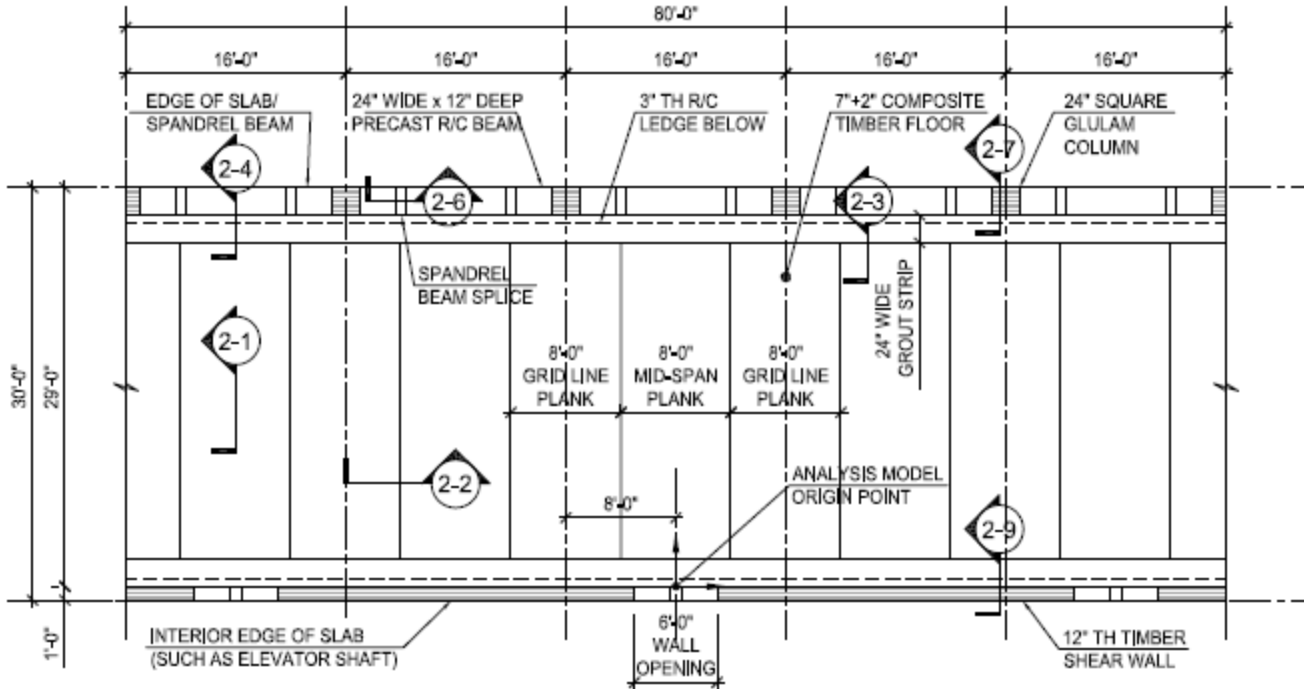

Figure 1-1: Plan Geometry

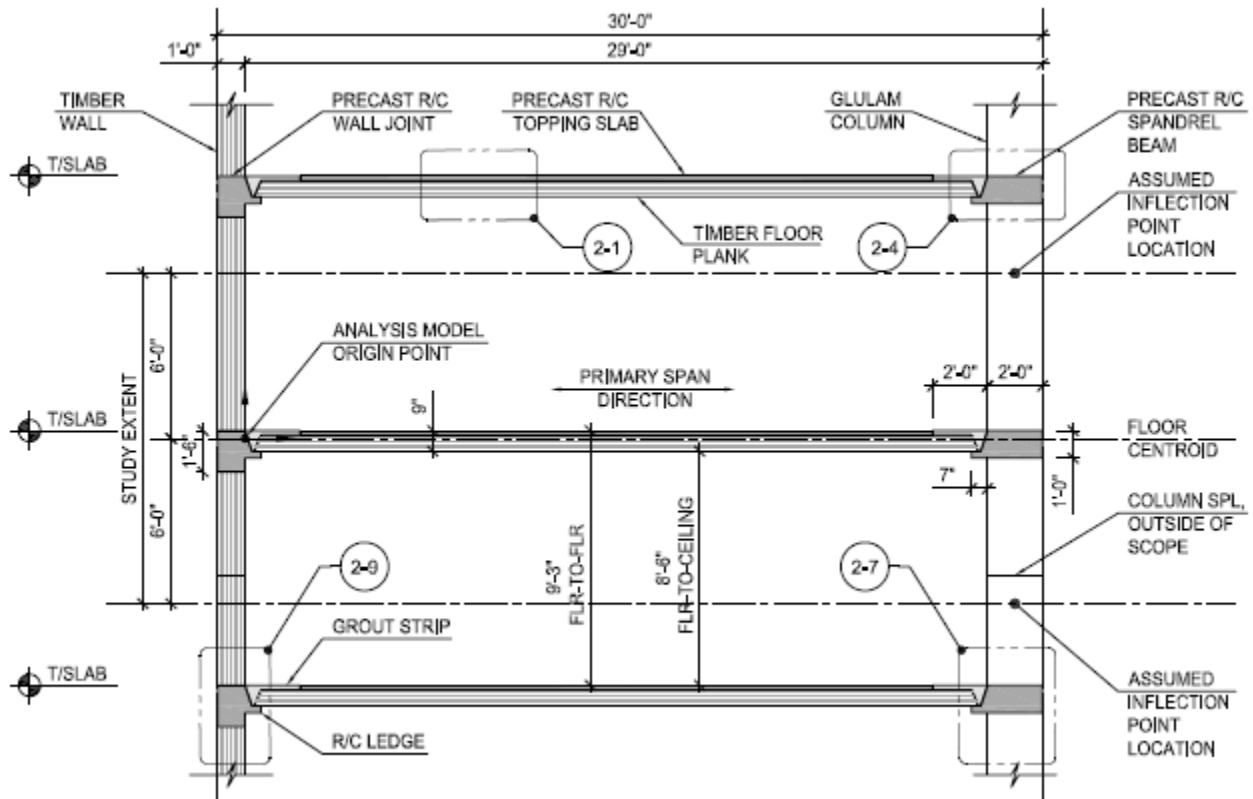

Figure 1-2: Elevation Geometry - Primary Span Direction

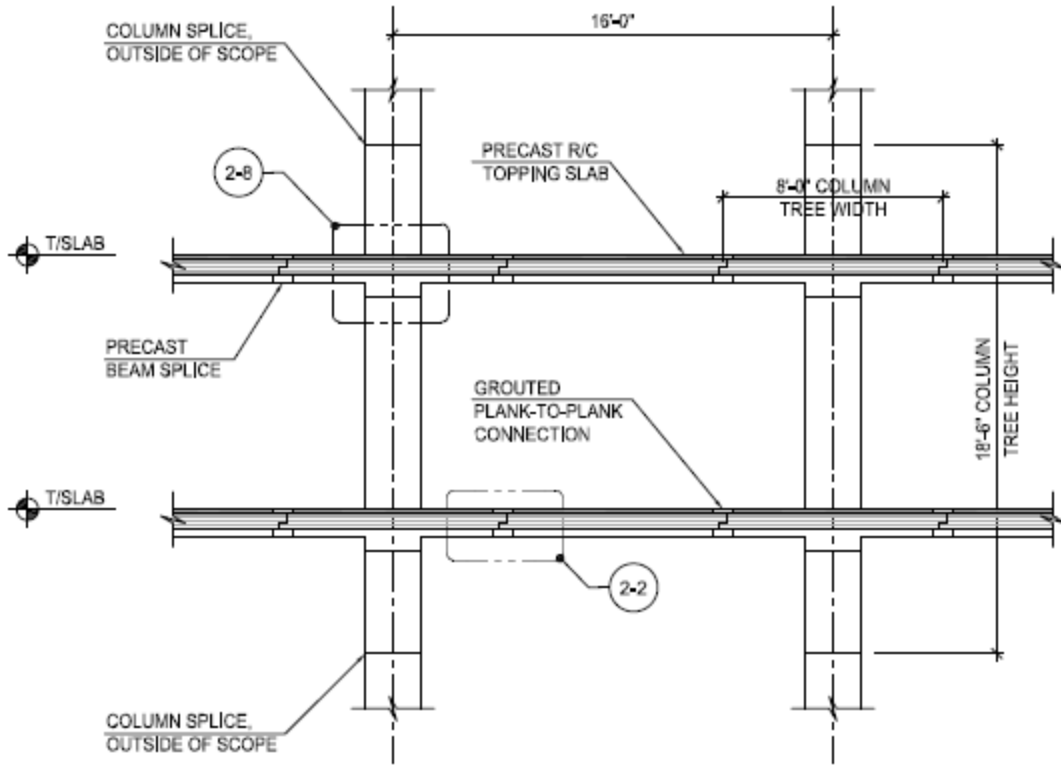

Figure 1-3: Elevation Geometry – Transverse Span Direction

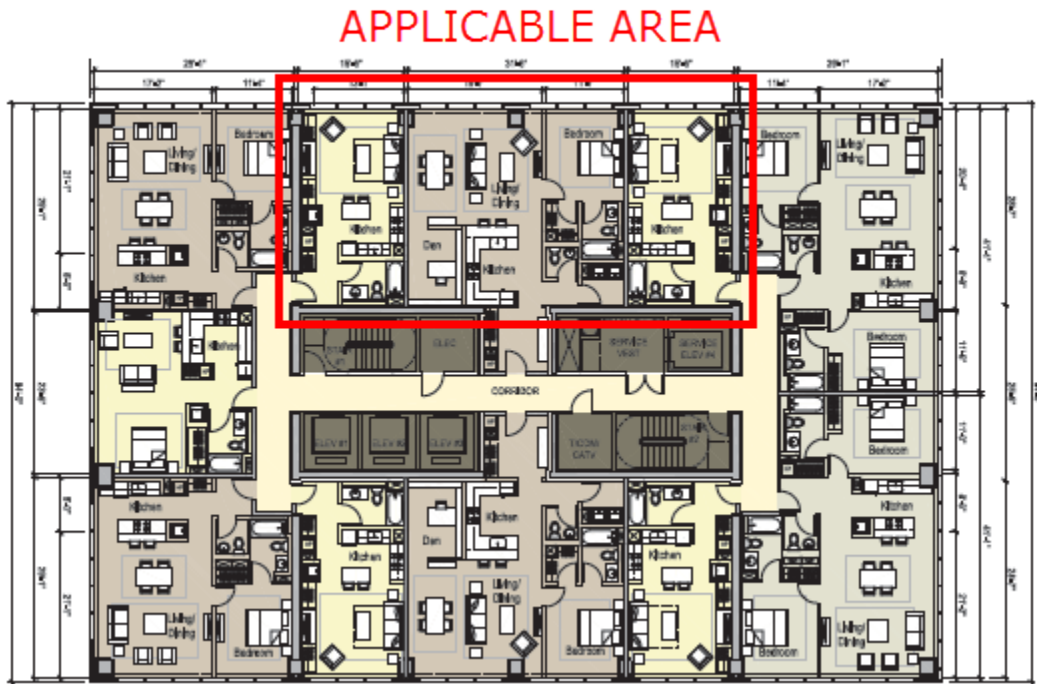

Figure 1-4: Applicability of Study Geometry to Prototypical Building from Initial Report



## 2.2 Study Geometry

The geometry studied was selected to represent the most typical layout for high-rise apartment construction. The geometry of the study follows the guidelines from Section 4 of the initial report. The lease span chosen was 29'-0", the maximum dimension for a rental apartment. The clear ceiling height in the living space was chosen to be 8'-6", the maximum dimension noted in the initial report. Columns follow an exterior wall module of 4'-0". The spacing of columns along the perimeter of the building would likely be variable in practice but was set as a constant for this study. The partition spacing for the prototypical building in the initial report was most typically 16'-0" on center and thus chosen for the column spacing in this study.

## 2.3 Structural Component Details

The current design configurations for the structural components for this report are shown in the following figures:

- Composite Mass-Timber Floor Planks: Figures 2-1, 2-2
- Floor Plank End Moment Connections: Figure 2-3
- Reinforced Concrete Spandrel Beam: Figure 2-4
- Reinforced Concrete Spandrel Splice: Figures 2-5, 2-6
- Reinforced Concrete Column Joint: Figures 2-7, 2-8
- Reinforced Concrete Wall Joint: Figure 2-9

The details shown in this section represent one potential way to achieve the desired behavior of the system. It is anticipated that these details will be refined by structural researchers through physical testing programs and by contractors through costing evaluations. The details shown in Appendix 3 should also be considered in addition to the base details of this section.

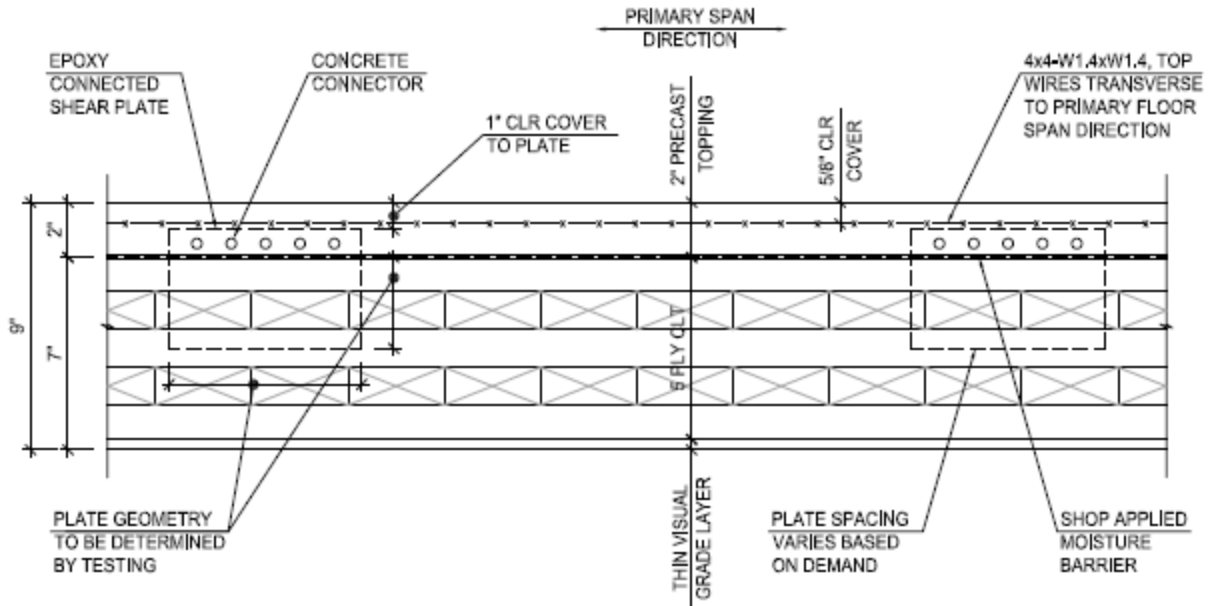

**Figure 2-1: Composite Timber Floor Section – Primary Span**

Notes: Composite action is achieved with the horizontal shear connectors shown. The shear connectors could consist of a steel plate connected to the CLT with epoxy and to the concrete with perforations in the plate, headed studs, or another protruding steel element (bolt head or threaded rod) which bears on the concrete. The placement and geometry of the shear connectors must consider fire resistance and char depths.

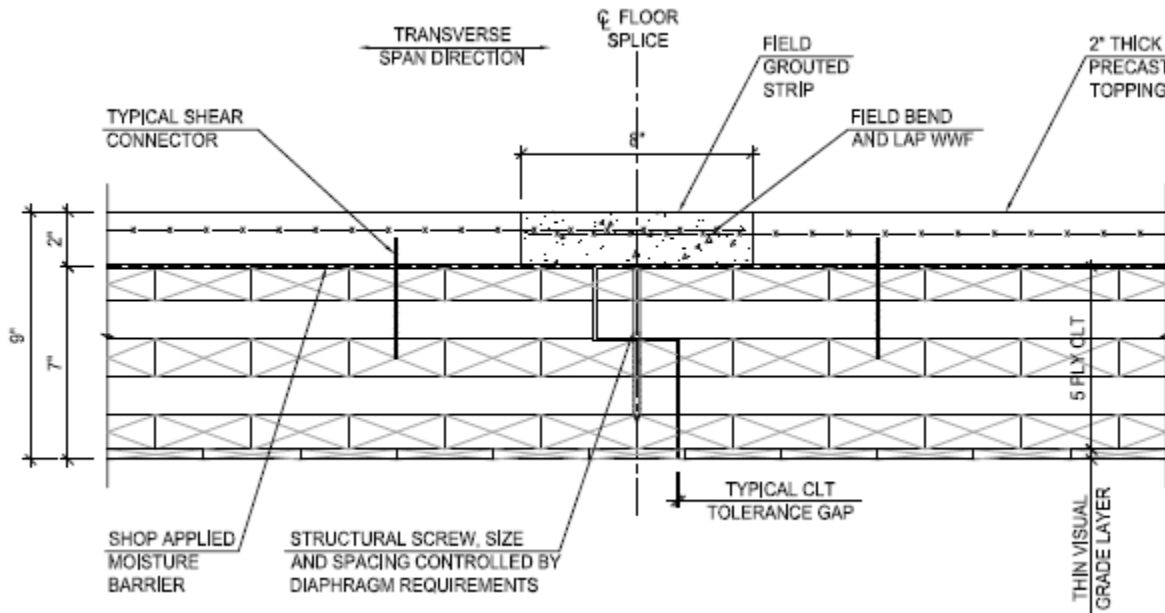

**Figure 2-2: Composite Timber Floor Section – Transverse Span**

Notes: A lapped CLT connection is anticipated. The vertical position of the ledge is shown above mid-thickness to limit exposure to charring in a fire. The size and spacing of screws would be designed to resist diaphragm shears due to lateral loading. The topping slab is field grouted at this location. The welded wire fabric must be 'field bent' outward at this location to avoid clashing with the adjacent floor planks during erection.

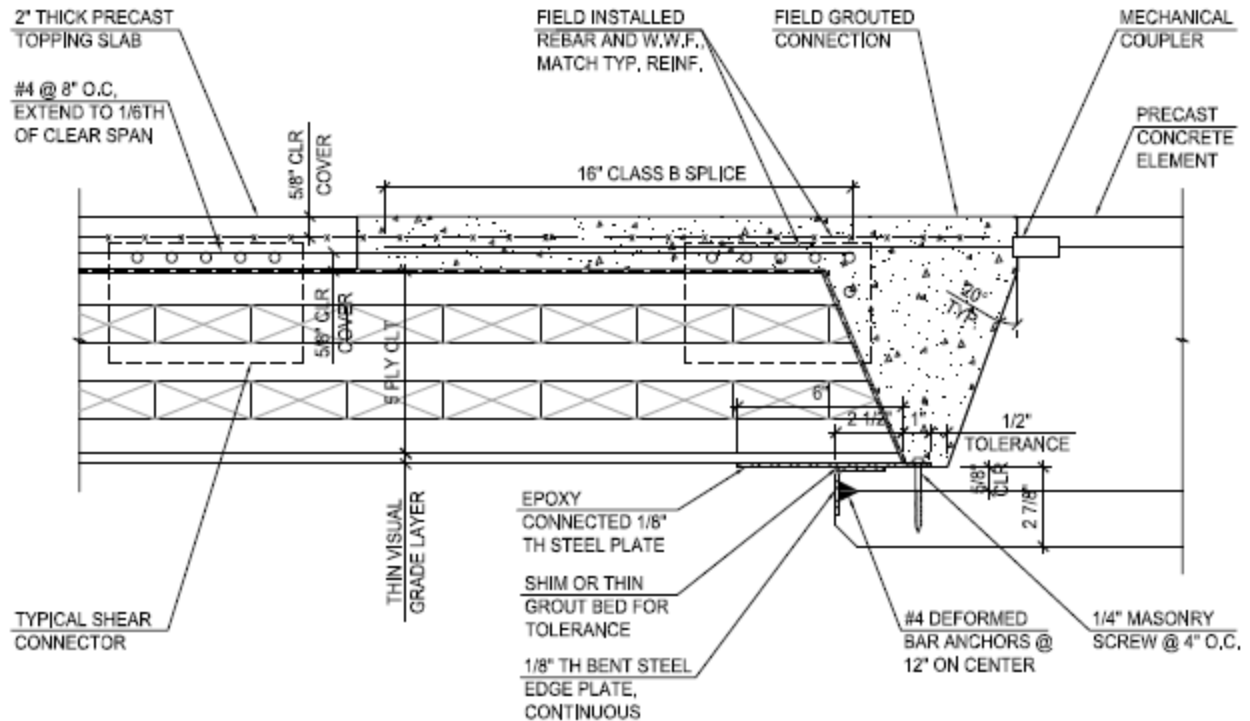

**Figure 2-3: Typical Floor Plank End Moment Connection**

Notes: The tension component of the end moment is resisted with a top reinforcing bar. The lap splice of the main top bar is a "Class B" splice since this is a tension critical location. Welded wire fabric above the splice is provided to restrain longitudinal cracking and aid in the development of the main bars. The main top bars are connected to the precast concrete with a mechanical coupler since "bend out" bars at this location may be difficult to construct. The compression component of the end moment is design to be resisted entirely by the epoxy connected steel plate on the bottom surface of the plank. This approach limits potential losses in stiffness due to shrinkage in the CLT plank, grouted connection, or precast concrete element. The compression in the plate is transferred to the precast concrete element through masonry screws. Masonry screws are chosen over protruding threaded rods to allow for greater setting tolerance. The compression plate is expected to be compromised in a fire event. The compression component of the negative bending moment is expected to be transferred by bearing between the CLT and grouted connection in a fire event.

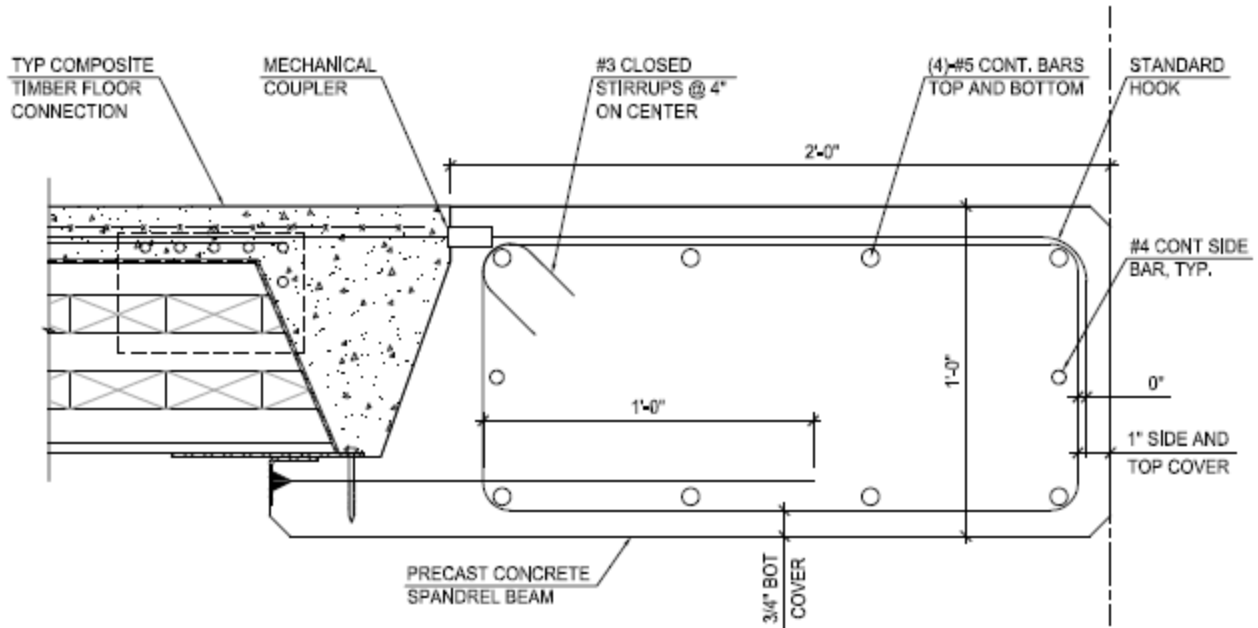

**Figure 2-4: Typical Reinforced Concrete Spandrel Beam Detail**

Notes: The beam is designed with smaller concrete covers allowed for precast beams.

Covers are adjusted on some faces to match the reinforcement geometry of the composite plank and concrete corbel deformed bar anchors.

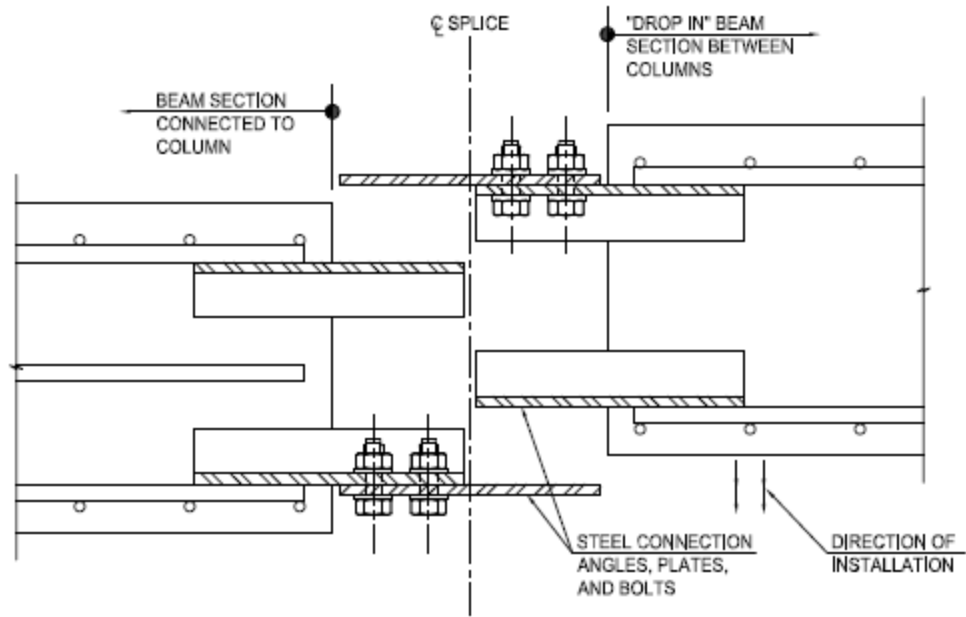

**Figure 2-5: Spandrel Beam Splice Field Erection Elevation Detail**

Notes: The splice as shown has shop bolted connection plates to the welded angles. These connections could be shop welded instead.

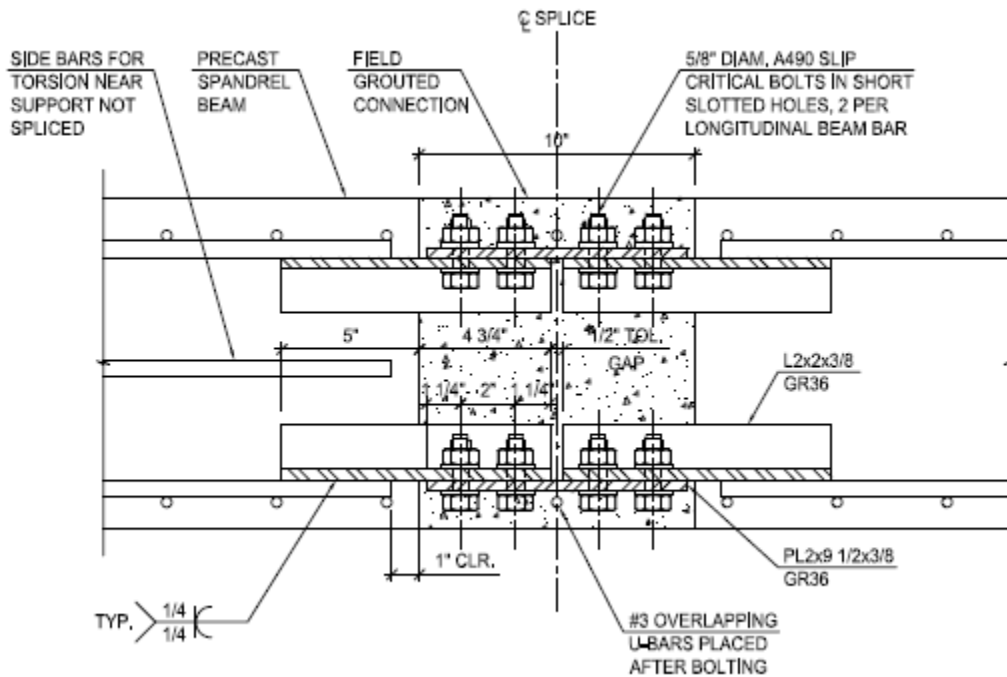

**Figure 2-6: Spandrel Beam Splice Final Condition Elevation Detail**

Notes: The detail shown is a robust detail which could develop a high percentage of the beams overall strength. This may not be required if splices are located near inflection points of the beam. A more economical beam splice detail may be possible when splices occur near inflection points, as shown in Figure A3-5.

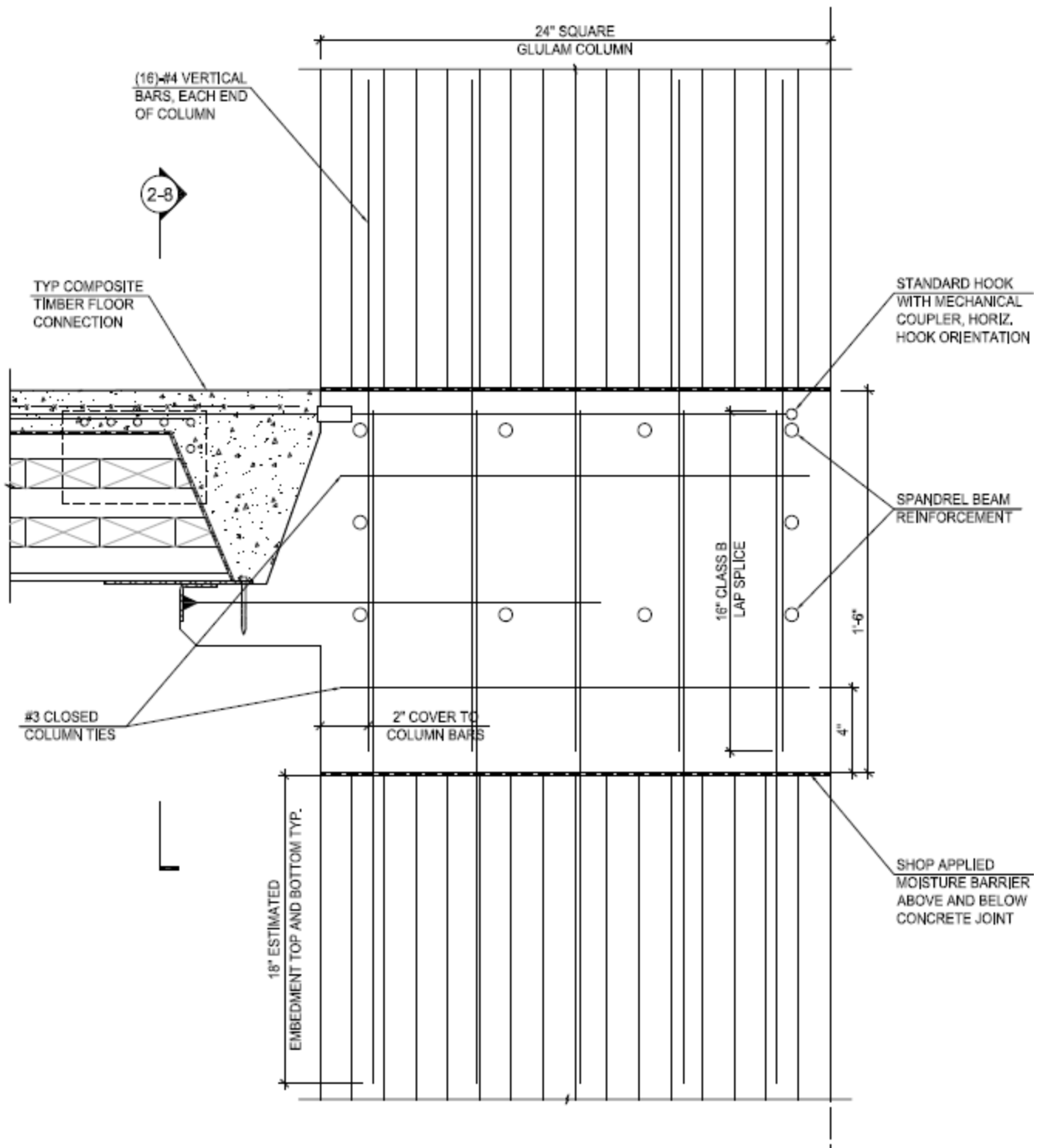

**Figure 2-7: Typical Column Joint Detail #1**

Notes: The connection of the column above and below to the precast joint is intended to be a precast/shop connection. The expected fabrication sequence is to connect the vertical dowels to the columns, place the reinforcing for the spandrel beam and joint, and then cast the spandrel beam with the columns off-site. Column splices occur 4 ft above the floor elevation and occur on every other floor.

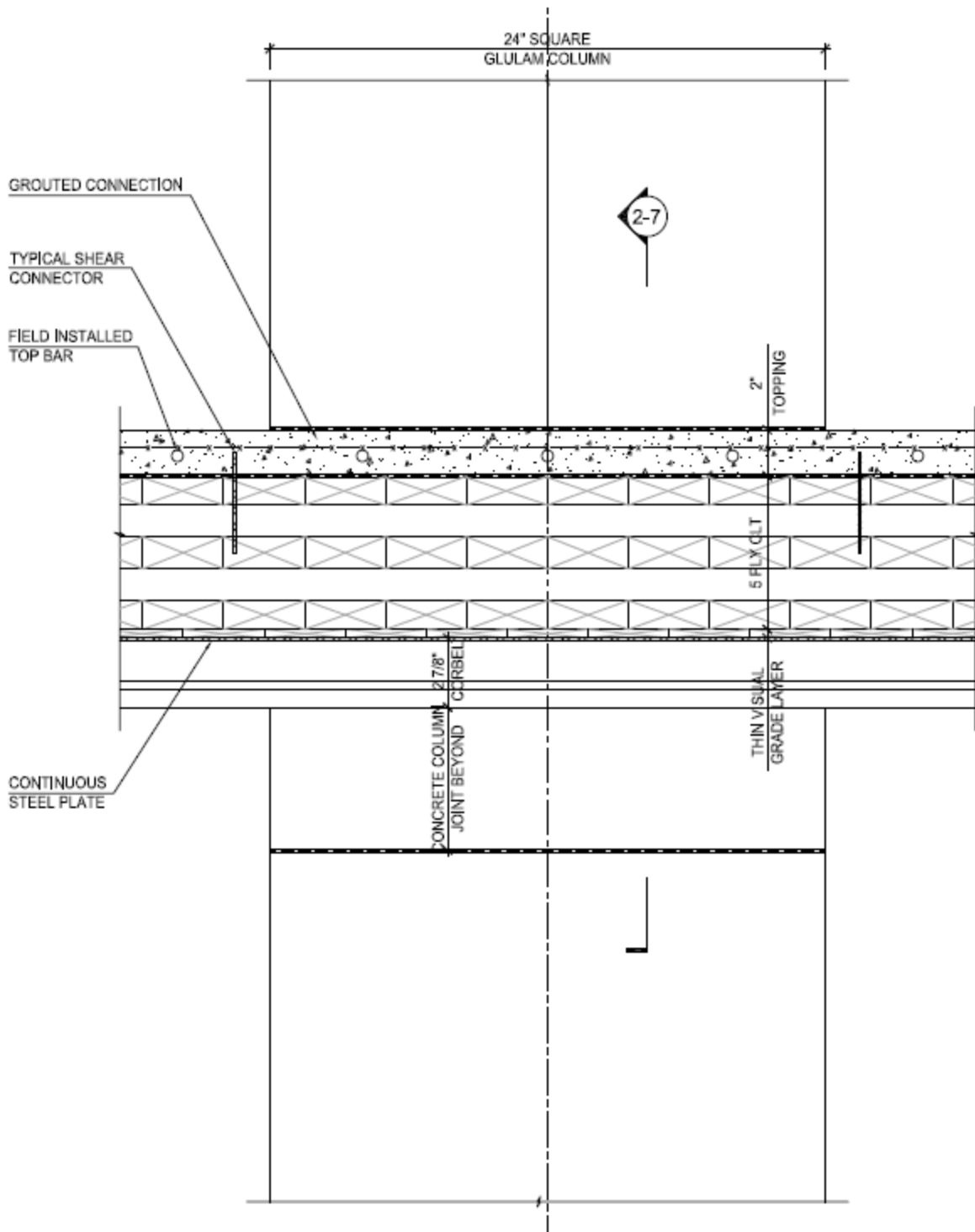
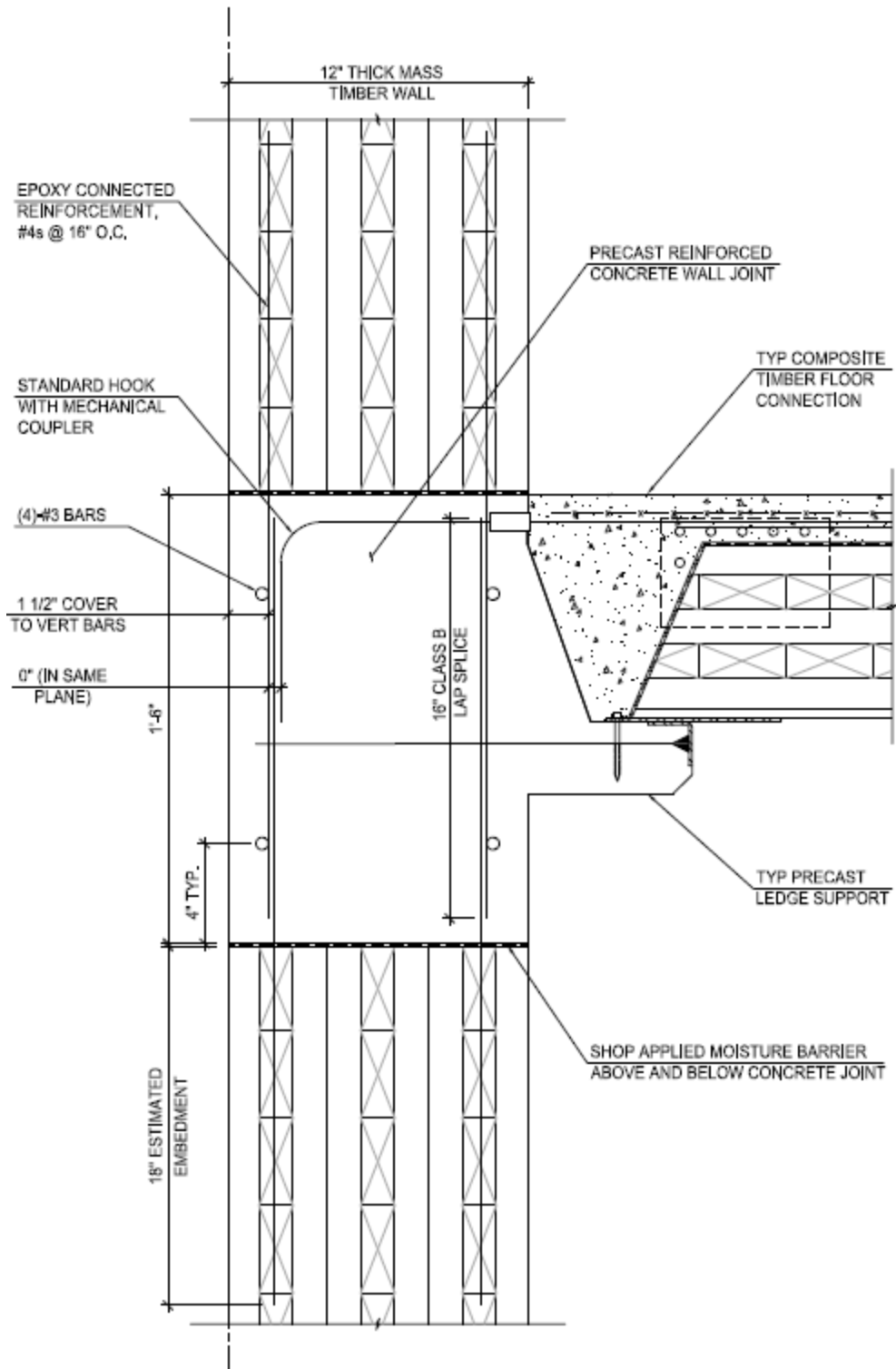

Figure 2-8: Typical Column Joint Detail #2



**Figure 2-9: Typical Wall Joint Detail**

Note: This detail follows a similar logic as Figure 2-7, with geometry adjusted for the wall.



## 2.4 Gravity System Design Behavior

The gravity system has been designed such that end rotation of the composite floor planks is restrained by the flexural stiffness of the columns and walls. Verification of this expected behavior is the primary aspect that requires physical structural testing for verification. The desired structural behavior is discussed below:

Floor Load Path: Figure 2-10

- Composite floor planks span gravity load to the supports
- Spanning creates horizontal shear between the timber and topping
- Floor planks bear on the concrete beam edge
- Floor plank end rotation is resisted by the typical moment connection

Spandrel Beam Load Path: Figure 2-11

- Spandrel beam spans floor plank reactions between columns
- Spandrel resists floor end moment with torsion near columns

Vertical Element Load Path: Figure 2-12

- Column/wall resists floor end moments in bending
- Column/wall shear reacts with levels above and below

Construction Sequencing Considerations: Figure 2-13

- Additional dead load deformation due to sequencing
- Reduced end moments due to sequencing

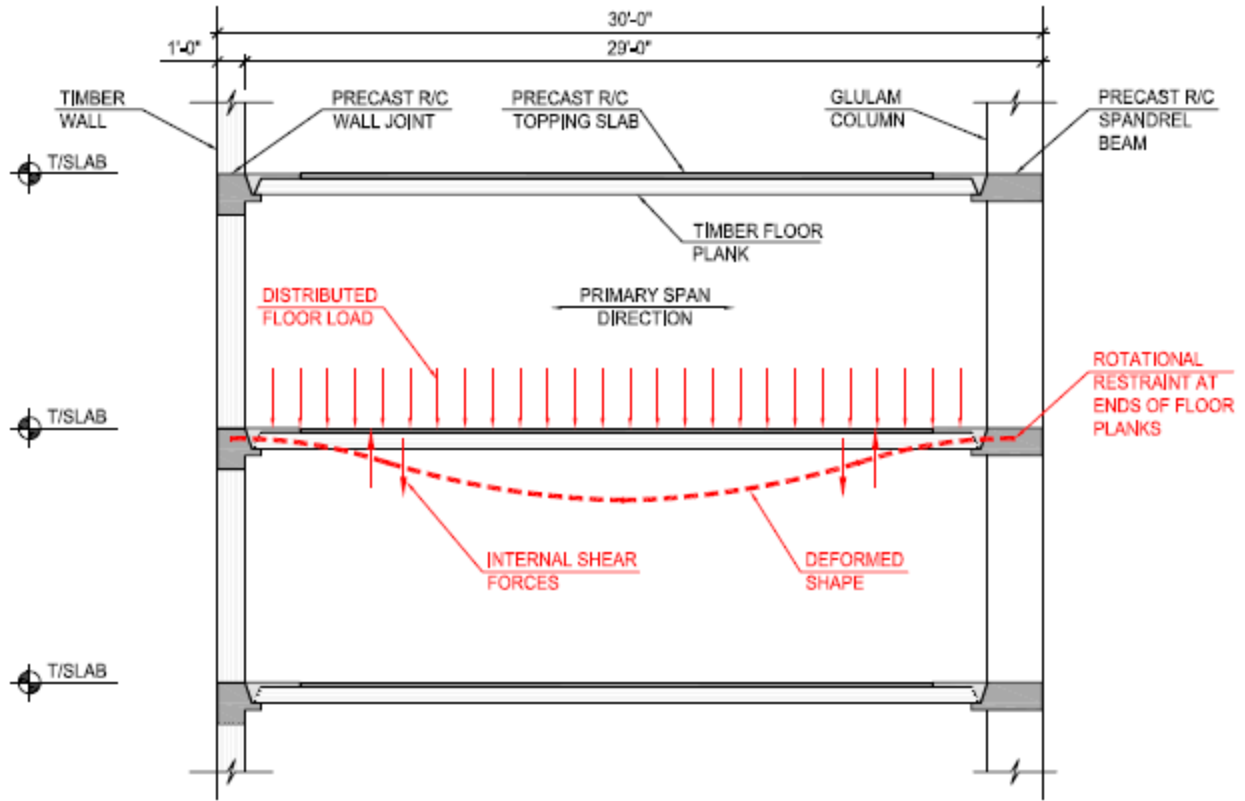

Figure 2-10a: Floor Spanning Behavior Design Assumption

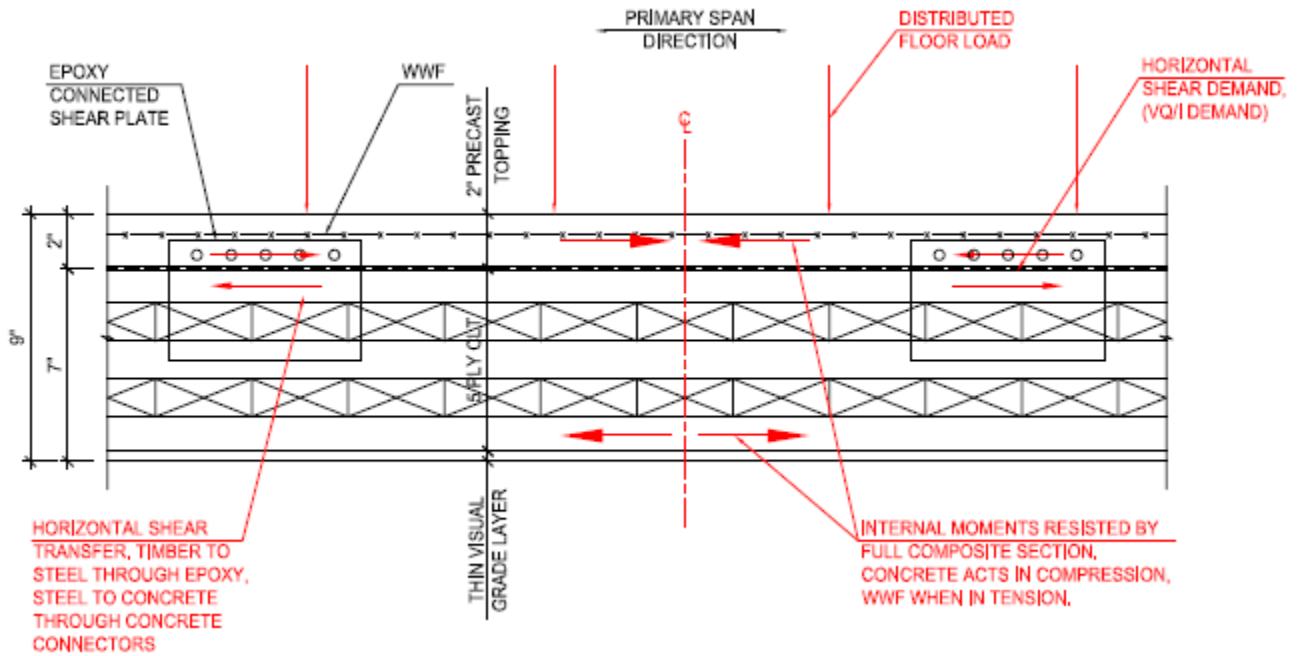

Figure 2-10b: Floor Composite Behavior

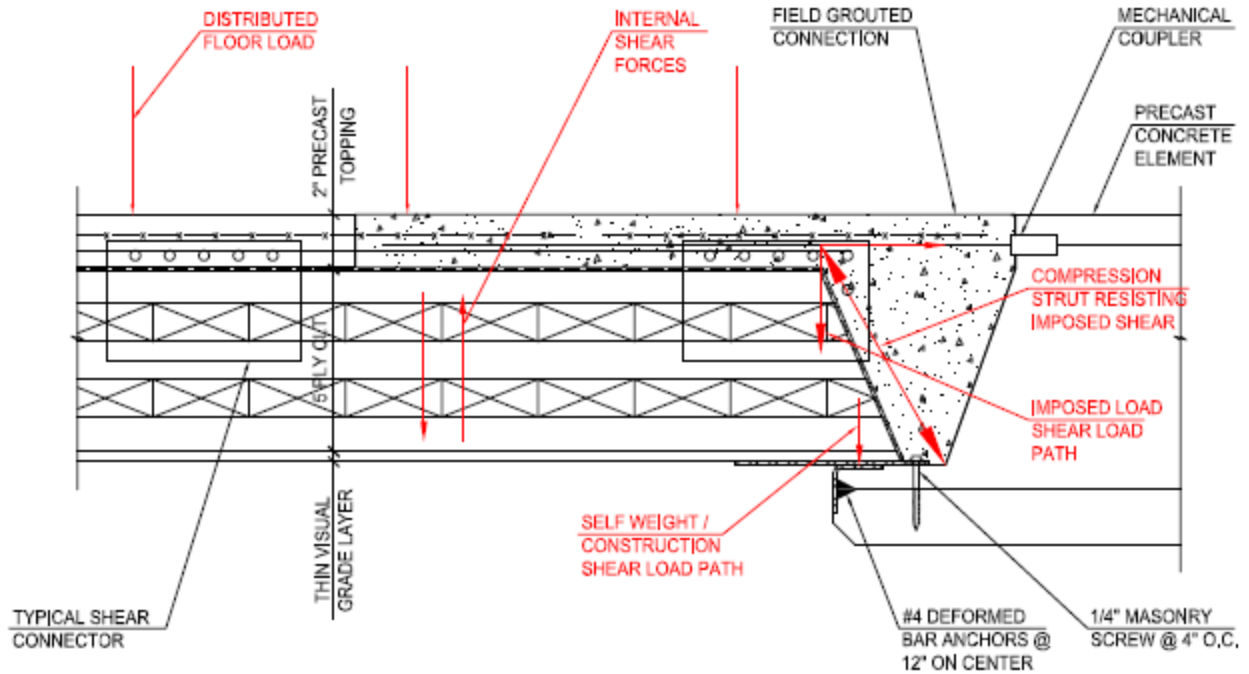

Figure 2-10c: Floor Shear Connection

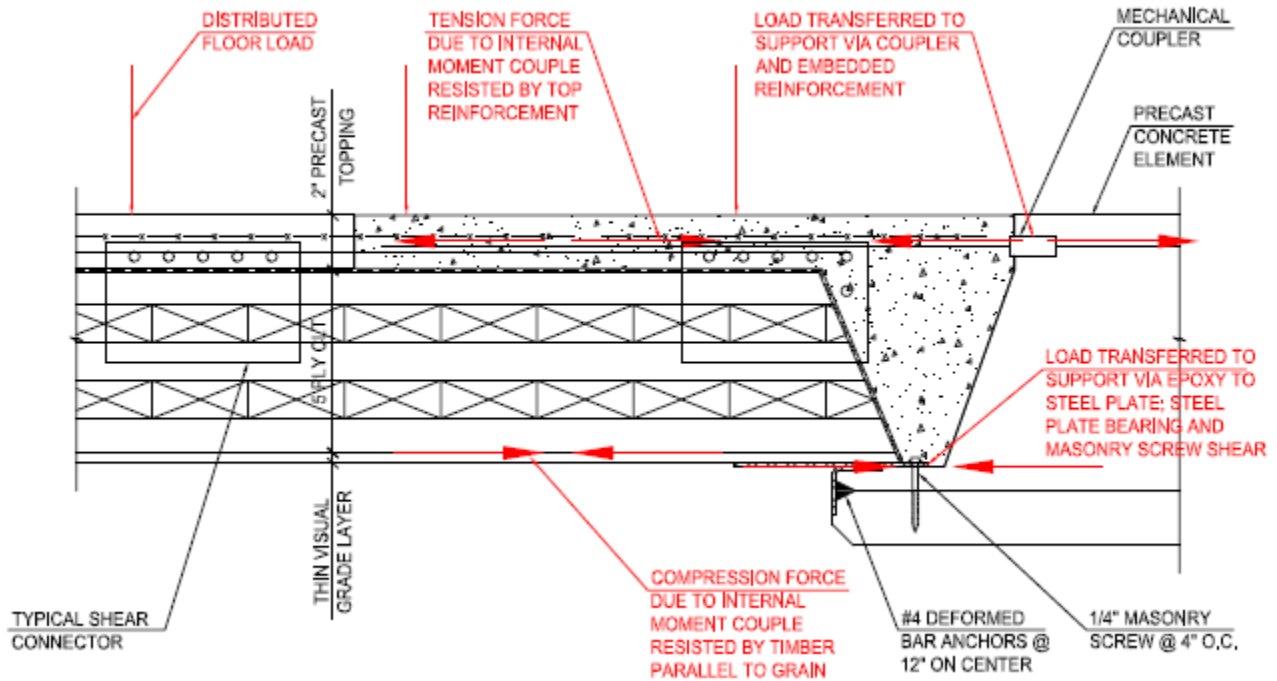

Figure 2-10d: Floor Moment Connection

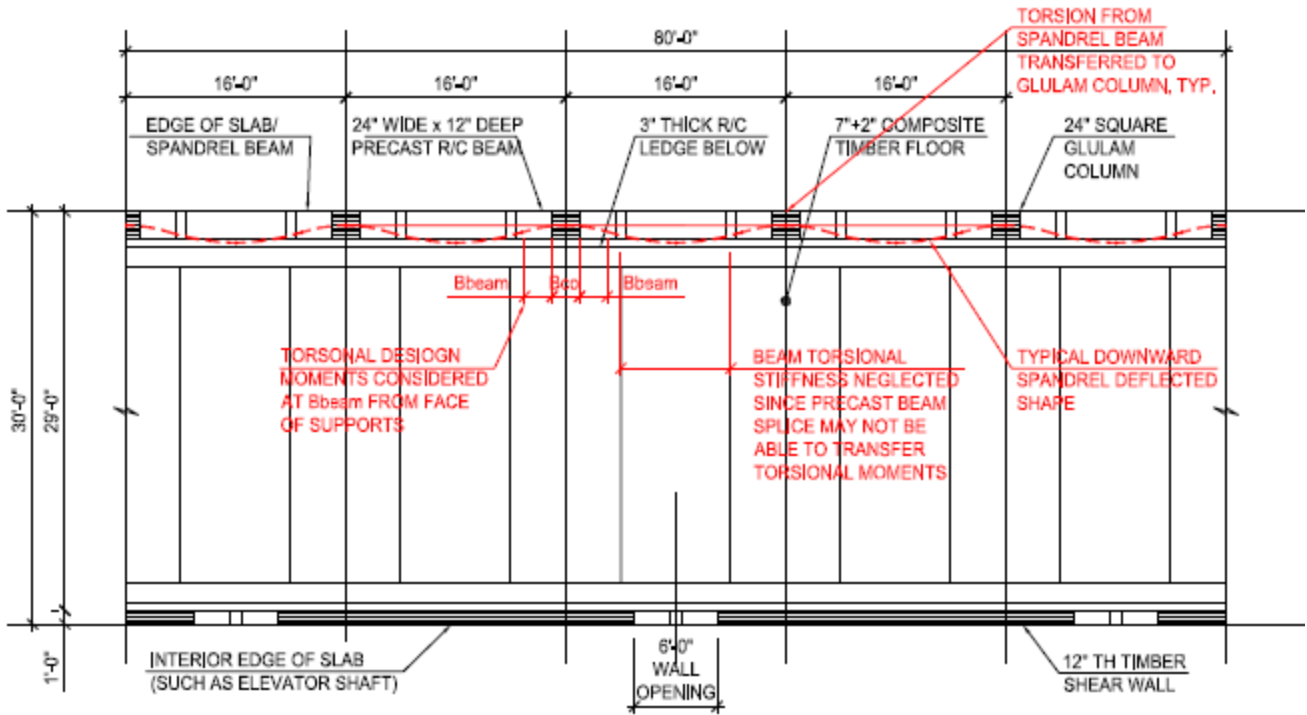

Figure 2-11: Spandrel Behavior

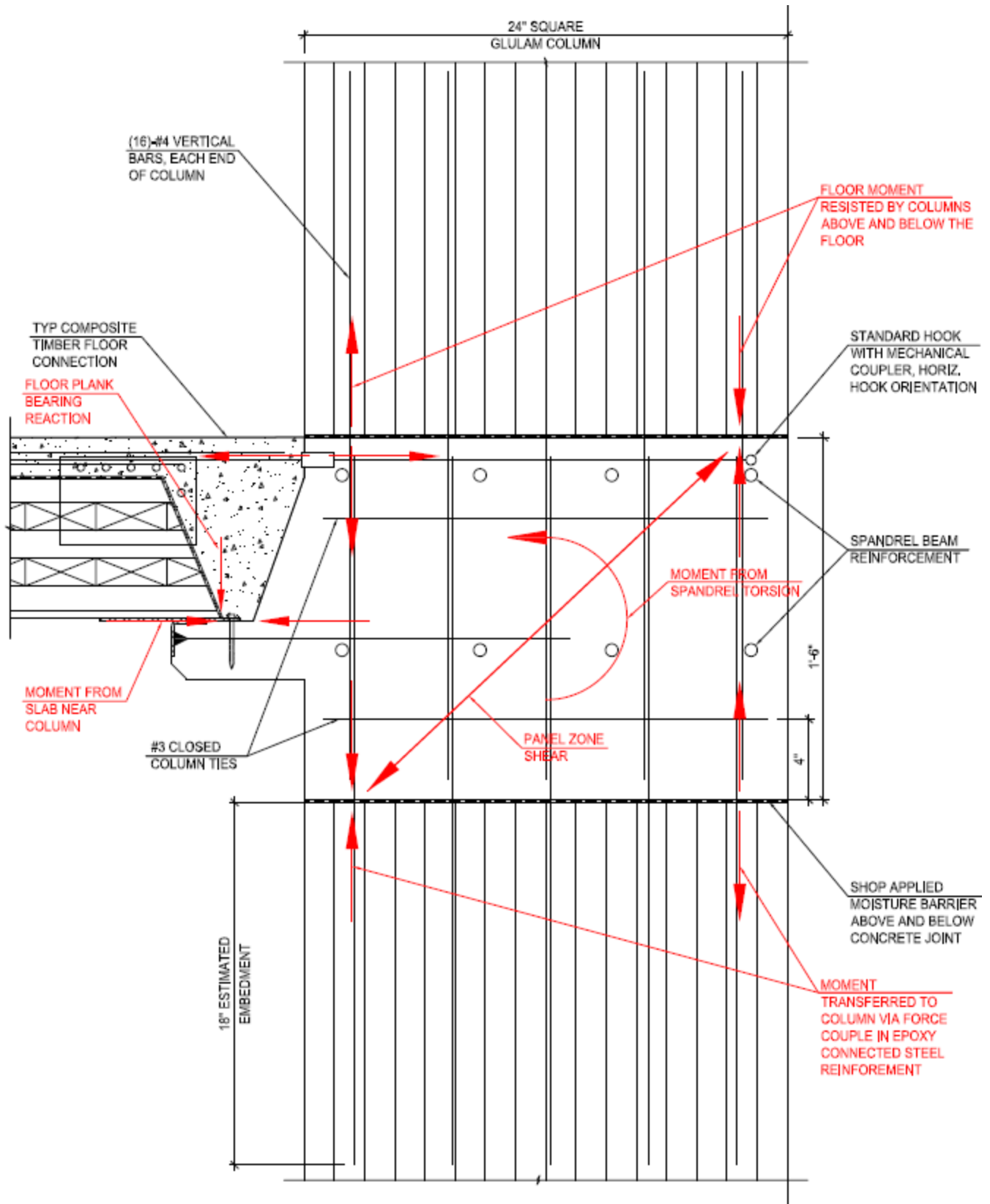

Figure 2-12a: Column & Wall (Similar) Bending Behavior

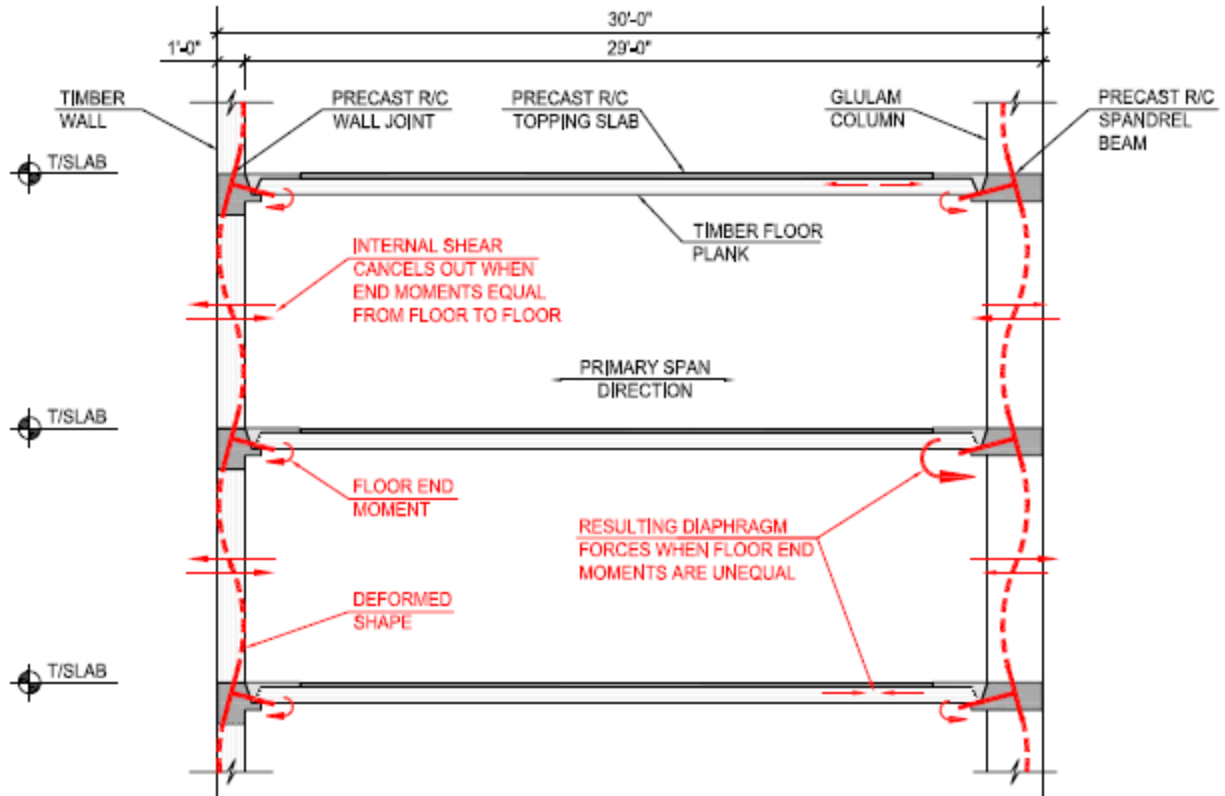

Figure 2-12b: Column & Wall Bending Behavior

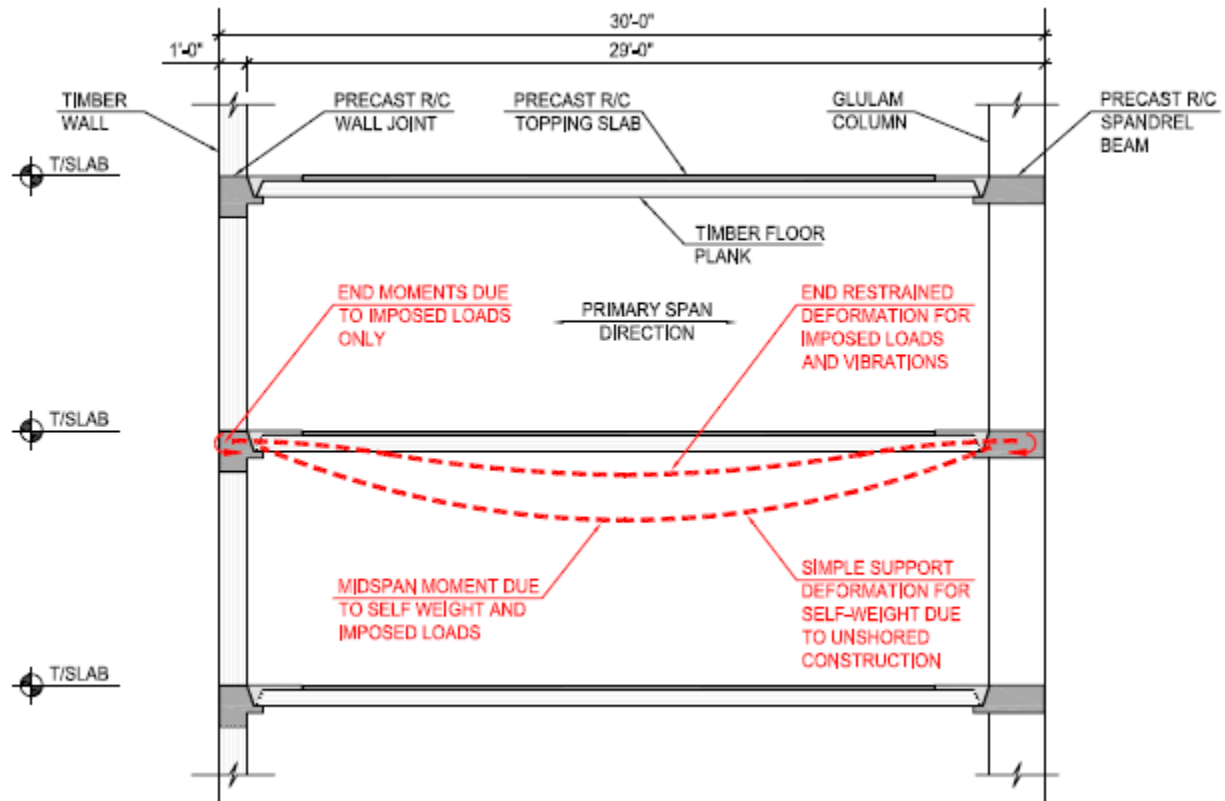

Figure 2-13: Construction Sequencing Effects

## Section 3: Design Criteria

### 3.1 Loading Criteria

The gravity framing system is analyzed and designed for the following loads:

Dead Load: Calculated based on design dimensions

- Density of mass-timber: 30 lb/ft<sup>3</sup>
- Density of concrete: 150 lb/ft<sup>3</sup> (considering reinforcement)
- Sustained/Expected load: 100%

Superimposed Dead Load: Partitions + CMEP

- Total Floor Load: 30 lb/ft<sup>2</sup>
- Exterior Cladding Load: 20 lb/ft<sup>2</sup> on vertical surface area
- Sustained/Expected load: 85%

Live Load: Residential Occupancy per ASCE/SEI 7-10 [1]

- Total: 40 lb/ft<sup>2</sup>
- Reduction: Possible for columns and spandrels but not considered
- Sustained/Expected load: 15% (6psf mean load per ASCE/SEI 7-10 Table C4-2)

### 3.2 Deflection Criteria

The gravity framing system designed to satisfy the following deflections:

Live Load: Deflection < Span/360

- Span measured center-to-center of supports

Total Load: Deflection < Span/240

- Span measured center-to-center of supports
- Includes long term deflections due to creep in timber and concrete
- Long term modifier taken as 2.0 based on [2] and [3]

### 3.3 Strength Criteria

The gravity framing system was designed to satisfy strength requirements of ACI-318 [2] and NDS-2012 [3] where applicable. Components outside the scope of these codes such as the bending strength of the composite floor section are evaluated with a first principles approach and will need to be confirmed with physical testing.

### 3.4 Vibration Criteria

The gravity framing system is designed to satisfy vibrations per AISC DG11 [4, 7].

Chapter 4: Design for Walking Excitation

- Residences:  $P_0 = 65\text{lb}$ ,  $\beta = 0.05$ ,  $a_0/g < 0.005$

Chapter 6: Design for Sensitive Equipment (velocity-based method)

- Tactual Perception Threshold:  $V = 8,000\mu\text{in}/\text{sec}$ , Moderate Walking Pace

## Section 4: Analysis Model

### 4.1 Model Description

#### Overall Description

The gravity system model for the concrete-jointed timber frame (CJTF) consists of five bays of composite mass-timber floor supported on the exterior by mass-timber columns and interior by mass-timber walls. The plan view of the analytical model is shown in Fig. 4-1.

The mass-timber floor has a clear span of 27'-0" with a narrow grout strip connecting the floor to the concrete joints located along the exterior column line and the interior wall line. The grout strip connection link is modeled using horizontal beam elements at each node of the floor mesh.

Walls are 1'-0" thick and are modeled 6'-0" above and below the floor. There are three 6'-0" openings spaced evenly along the length of the model.

Wall and floor geometry is modeled using shell elements. All shells are modeled with quadrilateral mesh with maximum size of 6"x6".

Timber columns are 2'-0" x 2'-0" and are modeled 6'-0" above and below the floor (to the approximate worst case inter-story inflection point). The columns are modeled using vertical beam elements.

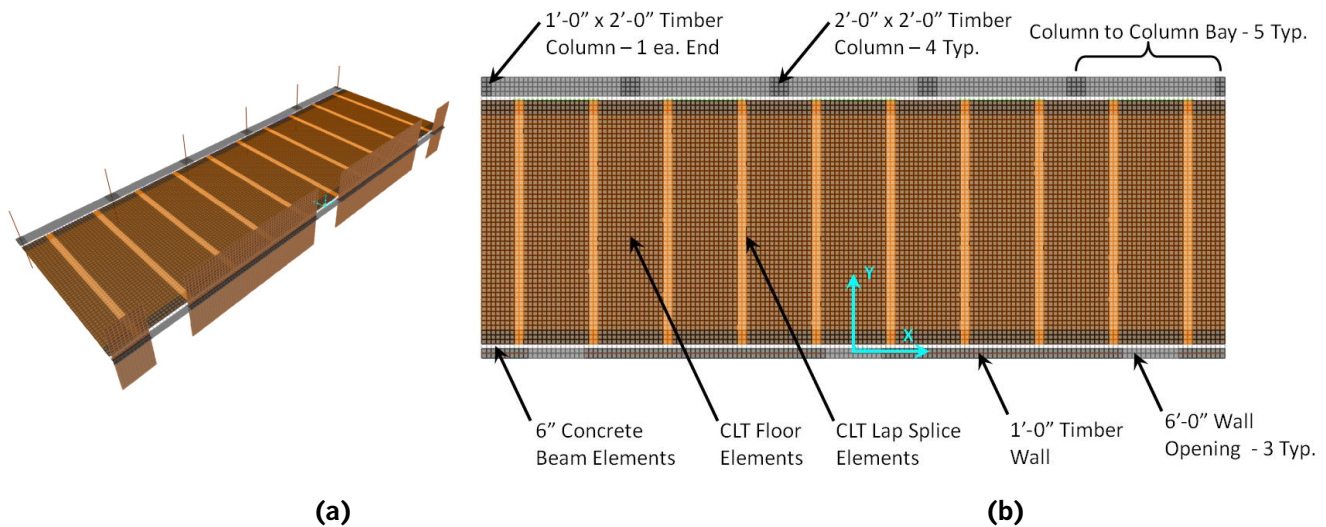

**Figure 4-1: Analytical Model (a) Isotropic (b) Plan**

#### Boundary Conditions

The base of the columns and the walls are pinned ( $x$ ,  $y$  and  $z$  translation = 0) and the tip of the columns and the walls are restrained for translation in  $x$  and  $y$ .

To model the floor as infinitely long in the direction perpendicular to the span, the following boundary conditions are applied to the floor elements: translation  $x = 0$  and rotation about  $y$  and  $z = 0$ .



The analysis model has two types of slab edge conditions corresponding to the composite behavior of the floor for both construction and in-service conditions. During construction, the grouted connections will serve as additional dead load, but will not contribute to floor stiffness. As a result, the slab is pinned (no moment connection) along the entire length.

Once the grout strip cures, the composite behavior will have moment connection at each edge. However, since the spandrel beam splice may not be able to transfer torsion, the joints are pinned for  $x > B_{\text{beam}}$  (2'-0") of each side of the exterior columns as shown in Fig. 4-2.

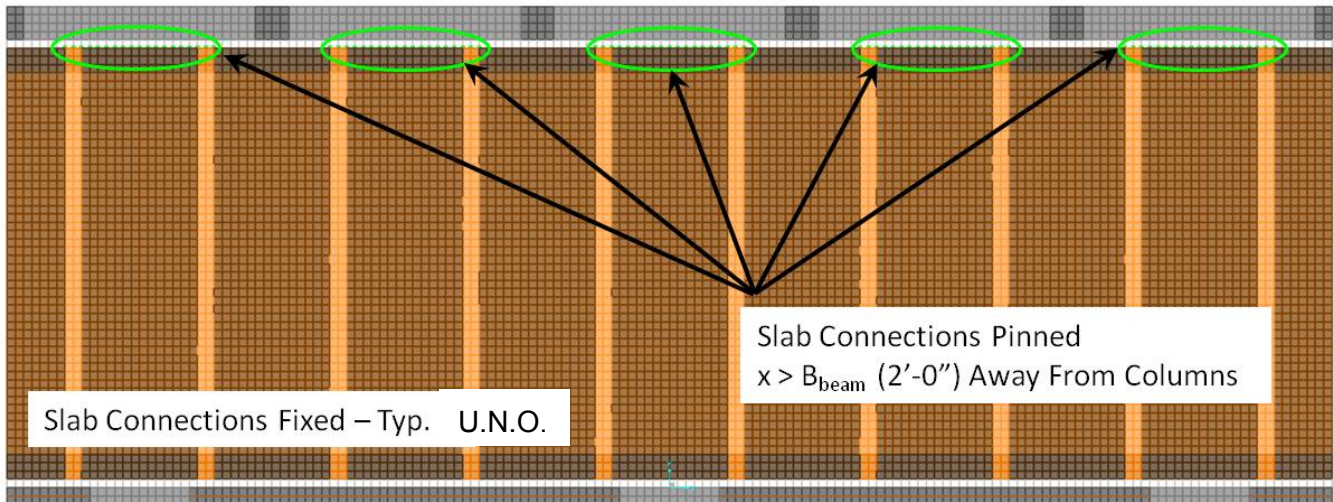

**Figure 4-2: Floor Boundary Conditions for Typical Service Condition**

## 4.2 Analysis Software

The computer model of the gravity system was developed using the finite element analysis program SAP2000 16.0.2, Computers and Structures Inc.

## 4.3 Analysis Inputs

### Material and Sections

The sections and materials used in the finite element model are provided in Tables 4-1 through 4-3. According to AWC-NDS2012, the mass-timber values modeled can be achieved with species that include, but are not limited to, Alaska Spruce, Douglas Fir-Larch, Douglas Fir-South, Hem-Fir, and Spruce-Pine-Fir [8].

Concrete values are for 4ksi and 5ksi normal weight concrete. The material modifiers for concrete were calculated according to ACI [2].

Material Name	CONC-4KSI	CONC-5KSI	TIMB-1
Weight per Volume, $\rho$	150pcf	150pcf	30pcf
Modulus of Elasticity, E	3,650ksi	4,070ksi	1,400ksi
Poisson's Ratio, U	0.2	0.2	0.44
Compressive Strength, $f_c / F_c$	4,000psi	5,000 psi	1,150 psi
Applicable Elements	Topping Slabs	Spandrels and Joints	All Timber Elements

**Table 4-1: Material Properties Used in Analytical Model**

The timber columns have property modifiers applied in the region of the floor to account for additional panel zone stiffness. The stiffness for these elements is increased in all directions as shown in Table 4-2 to account for nearly rigid panel zones. The grouted connection at the column and wall ends of the floor span has property modifiers applied for cracking.

Section Name	TIMB-24x12	TIMB-24x12-RGD	TIMB-24x24	TIMB-24x24-RGD	CONNECTION
Depth, t3	24in	24in	24in	24in	12in
Width, t2	12in	12in	24in	24in	6in
Material	TIMB	TIMB	TIMB	TIMB	CONC-5KSI
<b>Modifiers:</b>					
Shear Area 2-Dir	1	10	1	10	0.50
Shear Area 3-Dir	1	10	1	10	0.50
Torsional Const	1	10	1	10	0.10
MOI 2-Axis	1	10	1	10	0.50
MOI 3-Axis	1	10	1	10	0.11
Mass	1	1	1	1	1
Weight	1	1	1	1	1

**Table 4-2: Beam Sections Used In Analytical Model**

Horizontal shell elements have property modifiers applied. The local axes for all horizontal shell elements are aligned to global axes (i.e.,  $x = X$ ,  $y = Y$  and  $z = Z$ ). The axes are defined by SAP as follows:  $X=1$ ,  $Y=2$  and  $Z=3$ .

The property modifiers were calculated assuming plane sections remain plane (parallel axis theorem applies), transformed sections based on modular ratios, and that concrete has no stiffness above ACI calculated rupture stress. Additional reductions in stiffness for the mass-timber elements were considered according to the US CLT Manual [3].

Section Name	CONC-JOINT	PLANK-CRCK	PLANK-UNCR	SPANDREL-UNCR	SPLICE-CRCK	SPLICE-UNCR	TIMB-12IN	TIMB-12IN-RGD
Membrane Thick	12in	9in	9in	12in	9in	9in	12in	12in
Bending Thick	12in	9in	9in	12in	9in	9in	12in	12in
Material Name	CONC-5KSI	TIMB	TIMB	CONC-5KSI	TIMB	TIMB	TIMB	TIMB
<b>Modifiers:</b>								
Membrane f11	1	0.51	1.05	1	0.51	1.05	0.66	1
Membrane f22	1	0.51	1.05	1	0.51	1.05	0.66	1
Membrane f12	1	0.51	1.05	1	0.51	1.05	0.66	1
Bending m11	10	0.11	0.67	1	0.11	0.11	0.66	10
Bending m22	10	0.48	1.23	1	0.48	1.23	0.66	10
Bending m12	10	0.48	1.23	1	0.48	1.23	0.66	10
Shear v13	1	0.50	1	0.50	0.50	1	0.66	1
Shear v23	1	0.50	1	0.50	0.50	1	0.66	1
Mass	1	1.89	1.89	1	1.89	1.89	1	1
Weight	1	1.89	1.89	1	1.89	1.89	1	1

Table 4-3: Shell Sections Used in Analytical Model

The typical locations for application of the structural property modifiers in Tables 4-2 and 4-3 are shown in Figure 4-3.

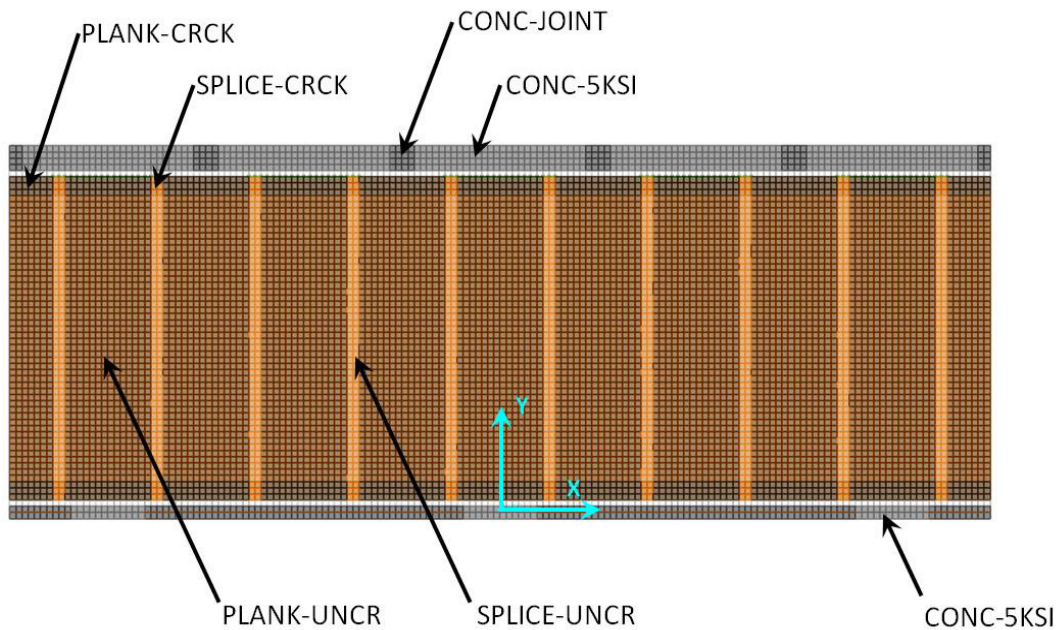

Figure 4-3: Typical Locations for Application of Section Modifiers

Loads

Gravity loading was applied according to ASCE 7-10. Factored combinations are also taken from ASCE 7-10.

Case	Load
DEAD	Self Wt
SDL	30psf
CLAD	184plf
LL	40psf
$\Delta p$	1000lb

COMBINATION	DEAD	SDL	CLAD	LL
G01	1.4*	1.4	1.4	0.0
G02	1.2*	1.2	1.2	1.6
S01	1.0*	1.0	1.0	1.0
S02	-	1.0	1.0	1.0
S03	1.0	0.85	0.85	0.15

\* Results for DEAD taken from construction model

(a)

(b)

**Table 4-4: Load Information (a) Cases (b) Combinations**

Load Patterns

Multiple live load patterns on a single floor were investigated as shown in Fig 4-4. The patterning of live loads on a single floor did not govern the design over a uniformly distributed live load on the entire floor. Results shown in this report are for live loads that were uniformly distributed over the entire floor analyzed. Live load patterning effects from load on floors above and below was considered in the assumed inflection point of the columns. Note that the floor to floor live load patterning has less than a 1% effect on the overall results presented.

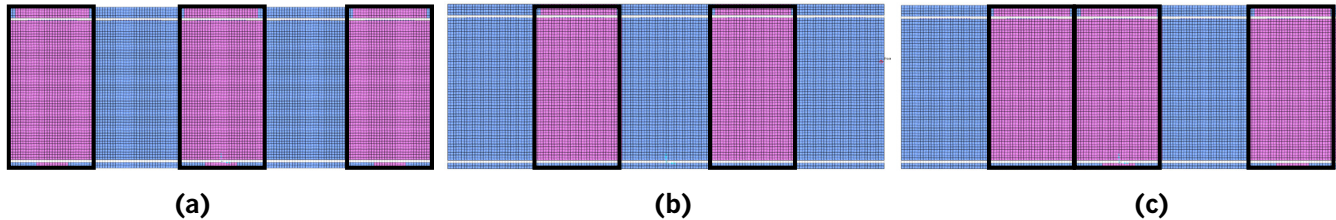

**Figure 4-4: Live Load Patterns Considered**

#### 4.4 Combination of Results

This system is designed so that construction can be unshored. The anticipated construction sequence is expected to cause additional dead load deflections and mid-span bending stresses as shown in Figure 2-13. Two analysis models were created to capture this expected behavior. The 'construction model' is used to determine shear forces, bending moments, and instantaneous deflections due to the self-weight of the structure. The 'service model' is used to determine shear forces, bending moments, and instantaneous deflections for the imposed loads. The service model is also used to compute long term deflections and evaluate vibrations. The combination of results is shown below with the subscript 'CONST' for construction model and 'SERV' for the service model.

- Shear Demands:  $DEAD_{CONST} + SDL_{SERV} + CLAD_{SERV} + LL_{SERV}$
- Moment Demands:  $DEAD_{CONST} + SDL_{SERV} + CLAD_{SERV} + LL_{SERV}$
- Instantaneous Deflection:  $DEAD_{CONST} + SDL_{SERV} + CLAD_{SERV} + LL_{SERV}$
- Sustained Deflection:  $DEAD_{SERV} + SDL_{SERV} + CLAD_{SERV} + LL_{SERV}$
- Long Term Deflection: Long Term Multiplier \* Sustained Deflection
- Total Deflection: Instantaneous Deflection + Long Term Deflection
- Vibrations: Service Model

## Section 5: Analysis Results

### 5.1 Data Output Conventions

Results for the floor are obtained for the load cases and combinations described in Sec. 4 at the section cut locations shown in Fig 5-1.

Results for the concrete spandrel are taken from (green) integration lines every 1'-0" o.c. column-to-column starting at the face of the column. The results for the timber floor are obtained for longitudinal (red) integration lines spaced at 2'-0" along the floor in the primary span direction. Results are obtained for the planks that are centered on the column grid (i.e., "gridline plank") and for those planks centered between columns (i.e., "mid-span plank"). Results for secondary span direction are obtained from sets of (blue) integration lines that run parallel to the span.

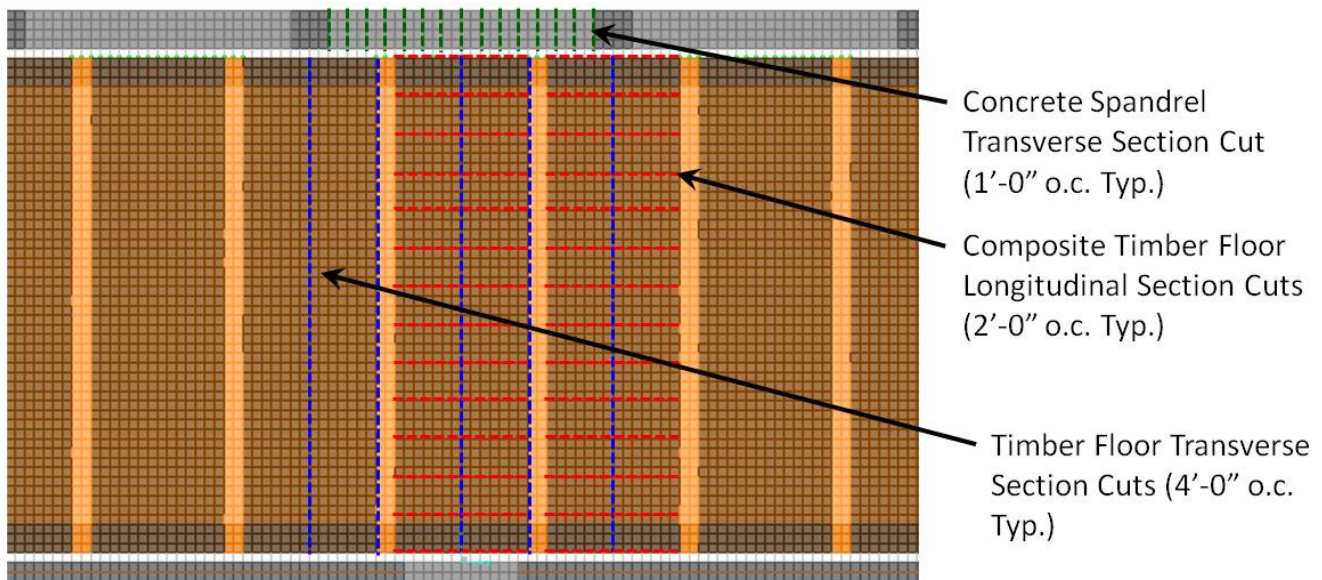

Figure 5-1: Section Cuts for Output Data

### 5.2 Reactions

Global reactions for the system are shown in Table 5-1.

Note that the CLAD load is supported by the exterior (i.e., along column line).

Case	Reactions [kip]	
	Column	Wall
DEAD	79.0	87.1
SDL	34.9	36.6
CLAD	14.8	0.0
LL	46.5	48.8

Table 5-1: Total Column and Wall Reactions for Each Load Case

### 5.3 Modal Results

The modal results for the system are shown in Fig. 5-2 and listed in Table 5-2.

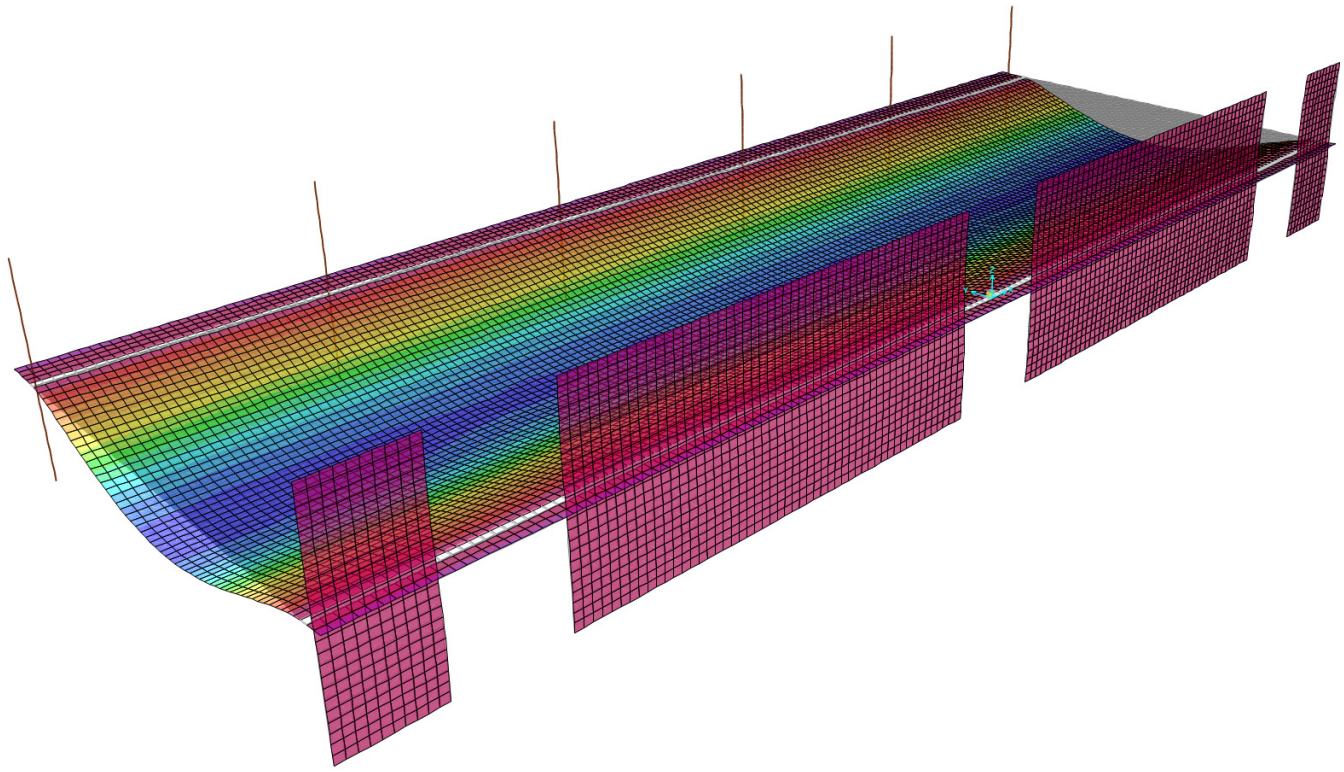

(a)

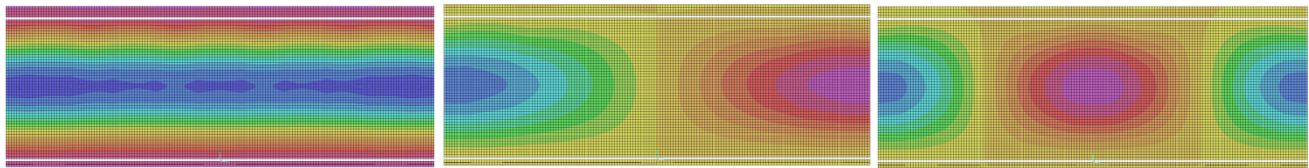

(b)

**Figure 5-2: (a) Fundamental Mode Shape,  $f = 7.32\text{Hz}$  (b) Plan View of First Three Modes**

Type	Number	Period	Frequency
		sec	cyc/sec
Mode	1	0.137	7.32
Mode	2	0.132	7.60
Mode	3	0.118	8.45
Mode	4	0.101	9.91
Mode	5	0.084	11.90
Mode	6	0.067	15.02
Mode	7	0.056	17.75
Mode	8	0.047	21.37
Mode	9	0.046	21.97
Mode	10	0.045	22.25
Mode	11	0.043	23.05
Mode	12	0.040	24.91

Table 5-2: Modal Results for the First 12 Modes of the Floor System

#### 5.4 Deformations

Contours and maximum values for displacement are provided for load cases for the simply supported construction case and the moment connected service case in Figs 5-3 through 5-8.

##### Construction Case

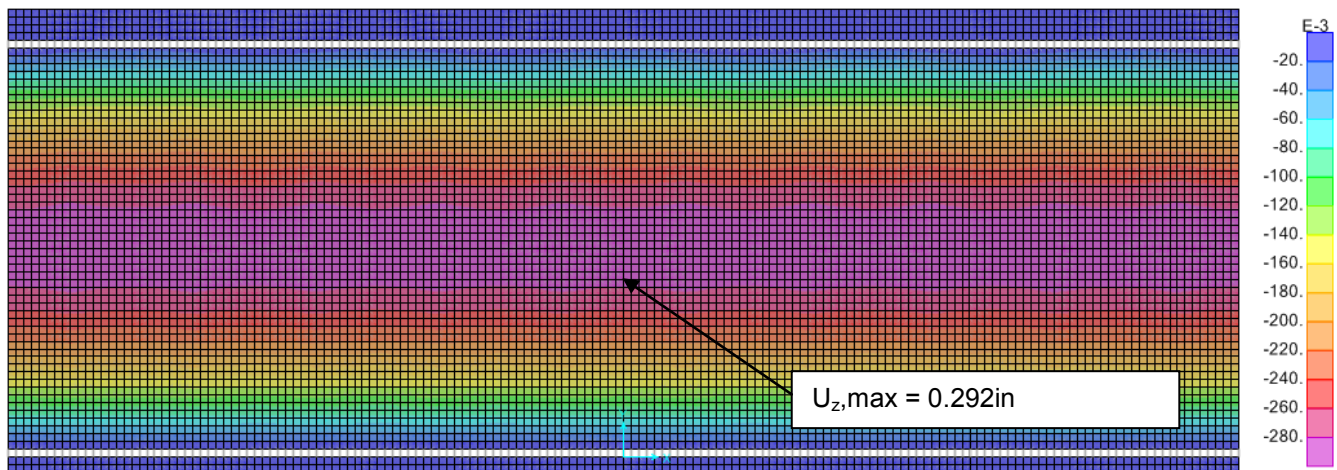

Figure 5-3: Deflection Contour for DEAD (Used for Instantaneous Deflection)



Service Case

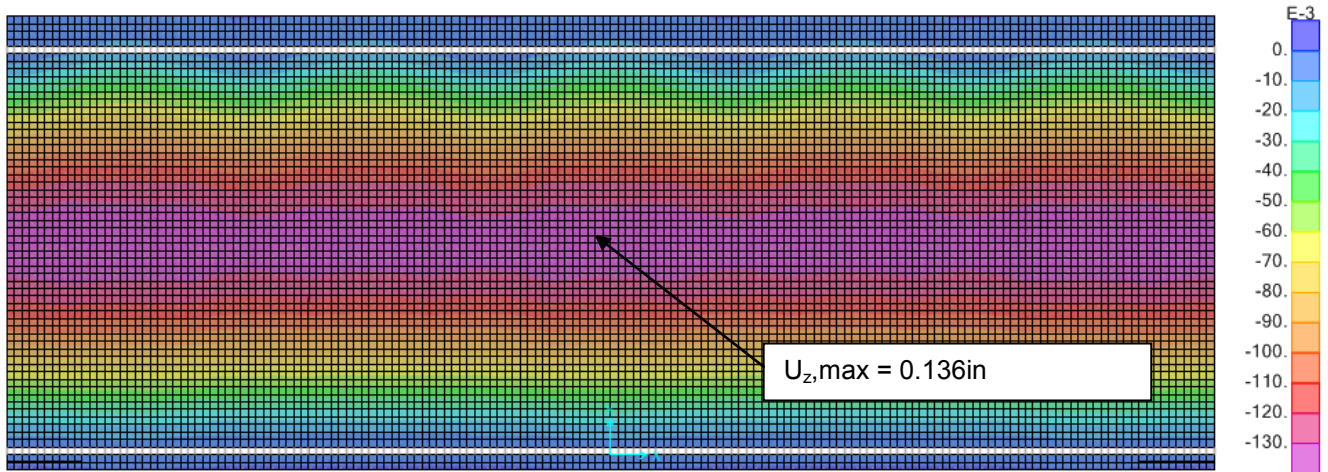

Figure 5-4: Deflection Contour for DEAD (Used for Long Term Deflection)

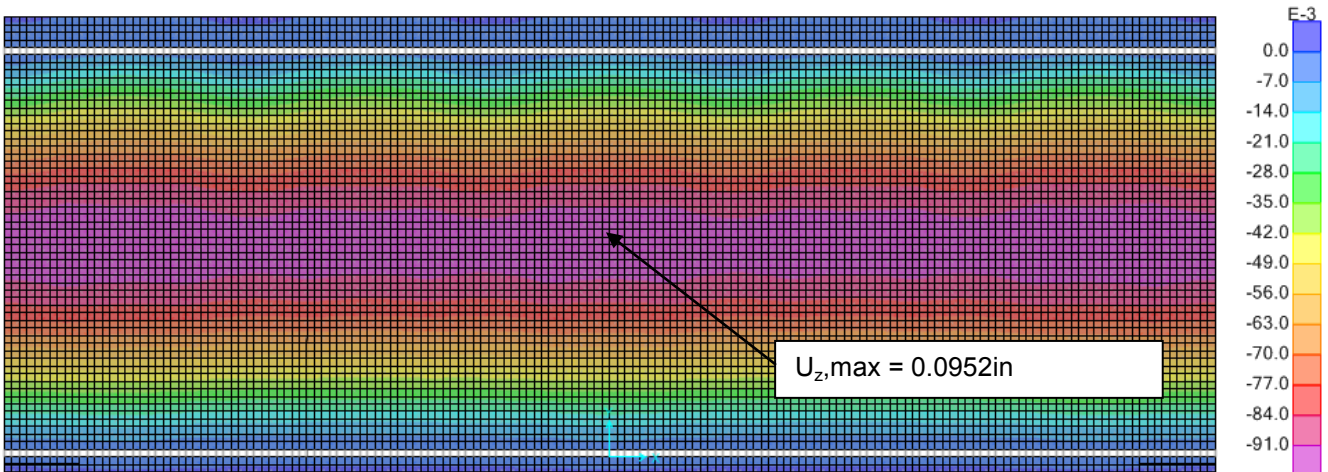

Figure 5-5: Deflection Contour for SDL

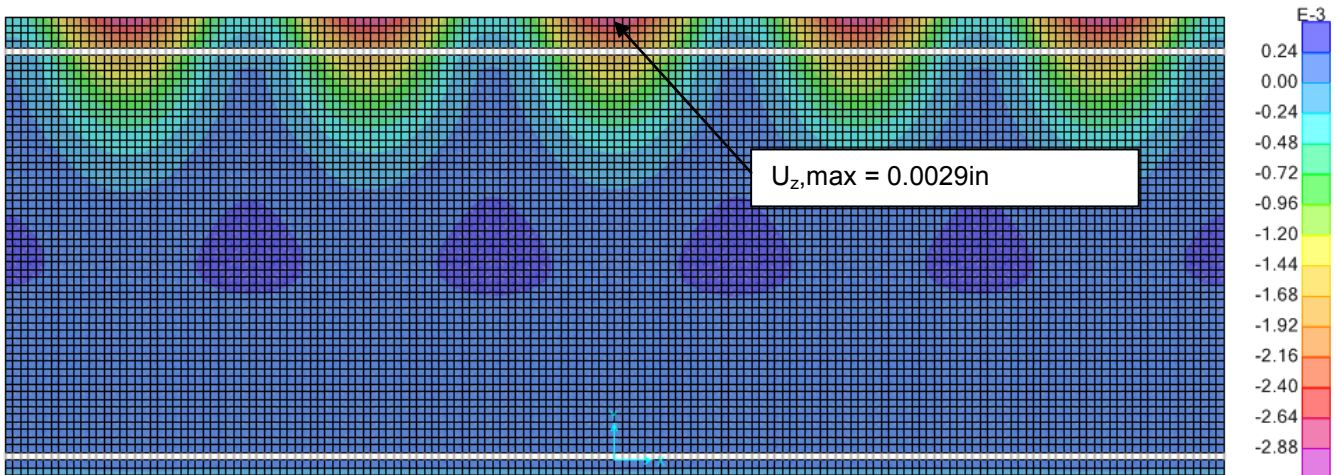
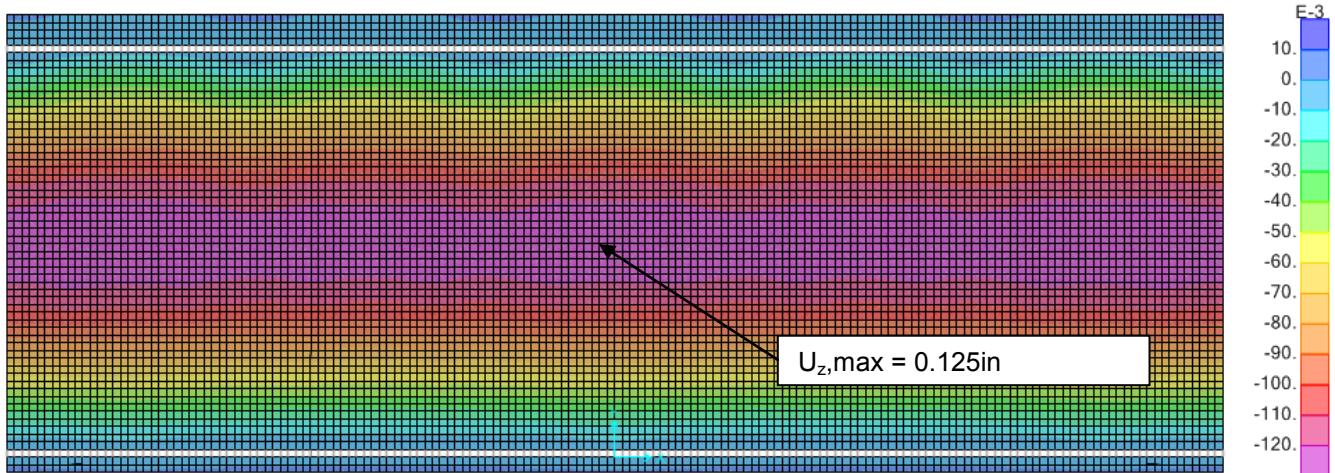
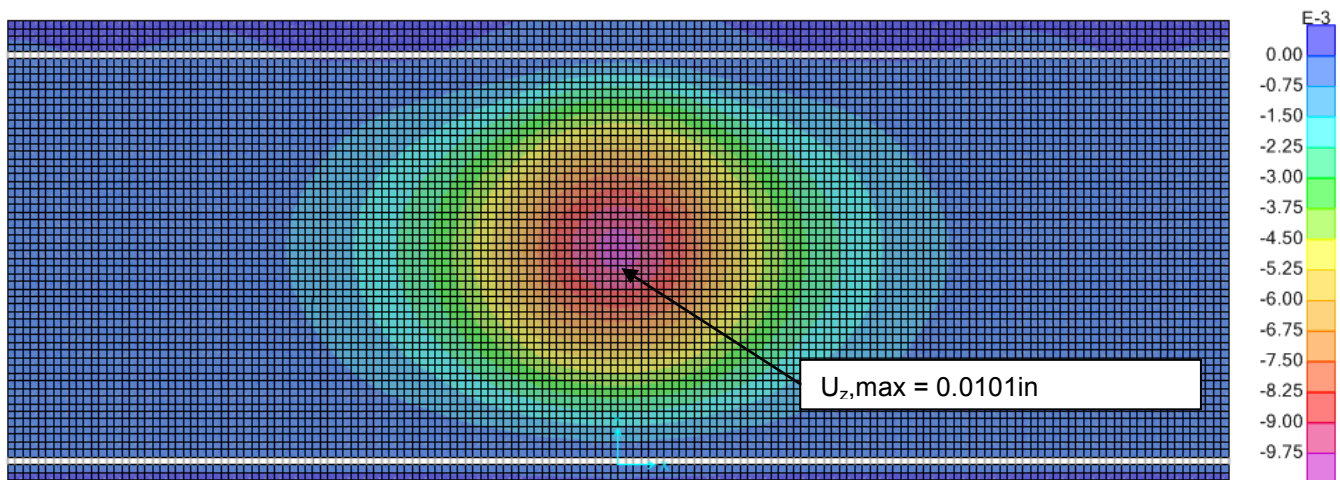

Figure 5-6: Deflection Contour for CLAD



**Figure 5-7: Deflection Contour for LL**



**Figure 5-8: Deflection Contour for  $\Delta p$  (1kip floor flexibility load)**

Figures 5-9 and 5-10 show the deflection plots for the mid-span plank under various load cases and combinations. Note that the dead load displacement is obtained from the construction case (i.e., simply supported) and is used as the dead load in the load combinations.

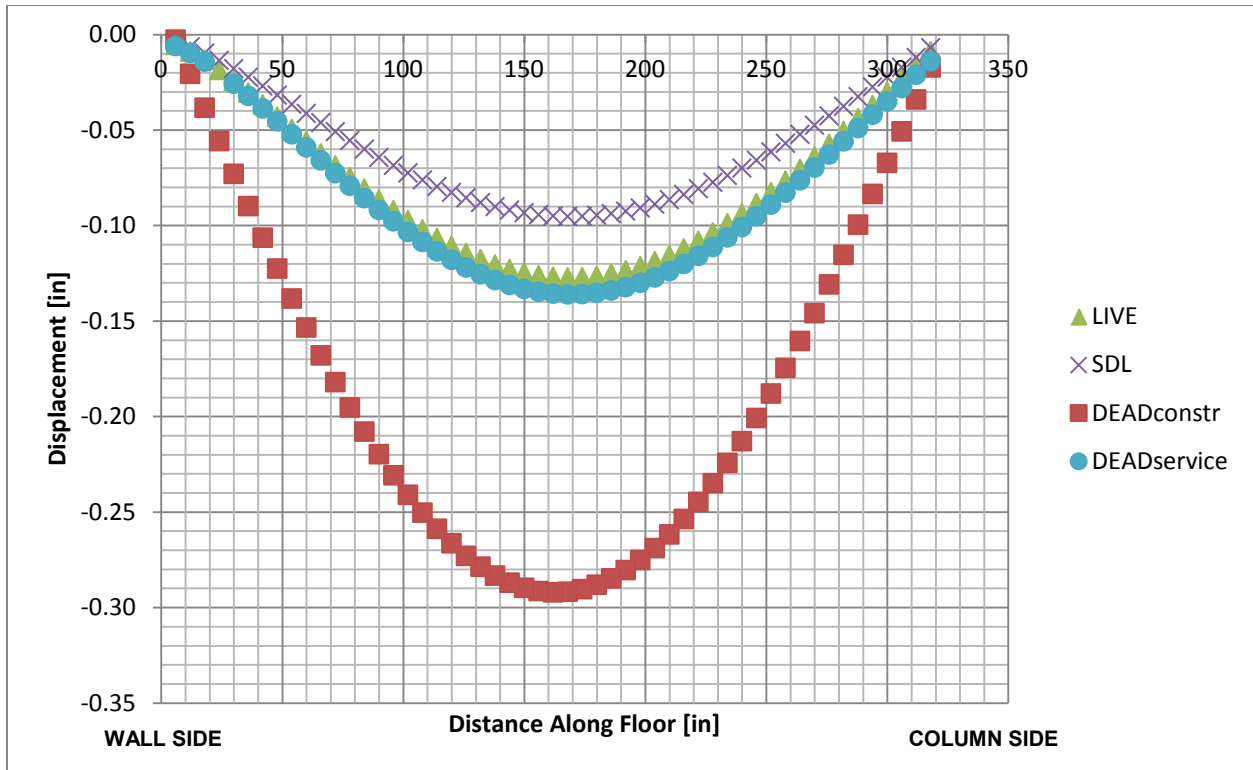

Figure 5-9: Deflection Plot for Timber Floor Along Span for Load Cases

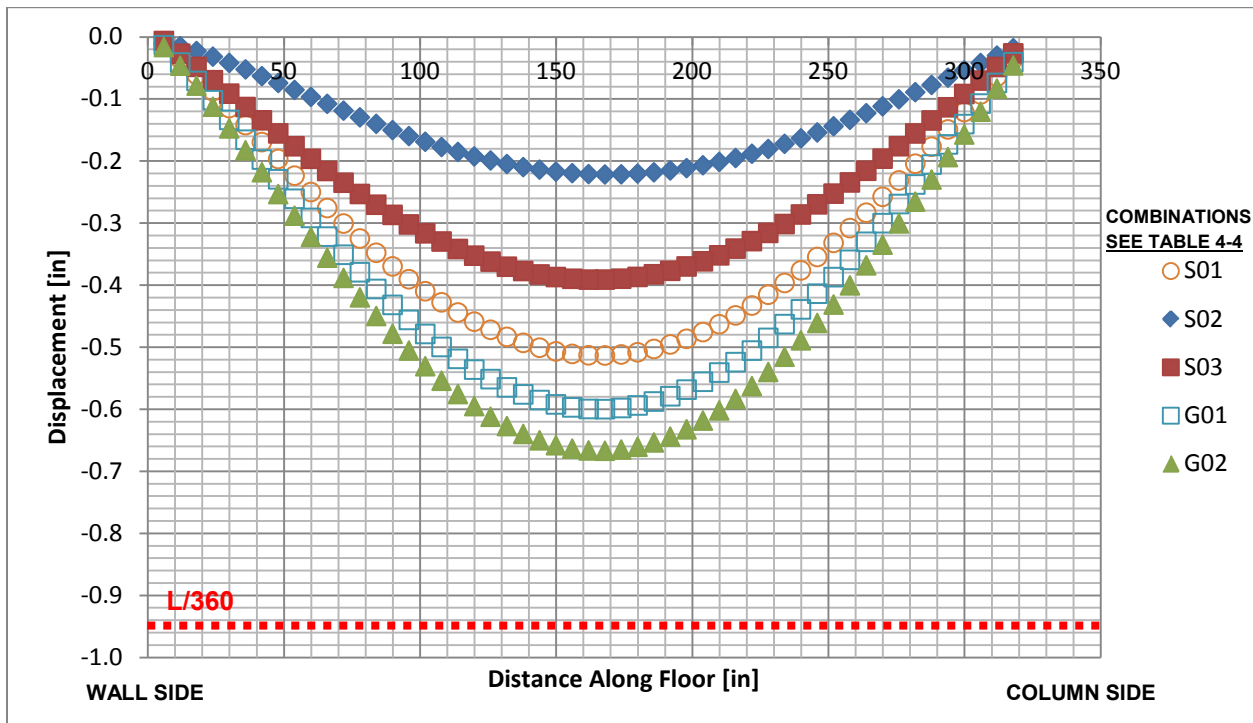

Figure 5-10: Deflection Plot for Timber Floor Along Span for Load Combinations

## 5.5 Shear Demands

Shear demands are shown in Figs 5-11 through 5-13 for the construction and service cases.

### Construction Case

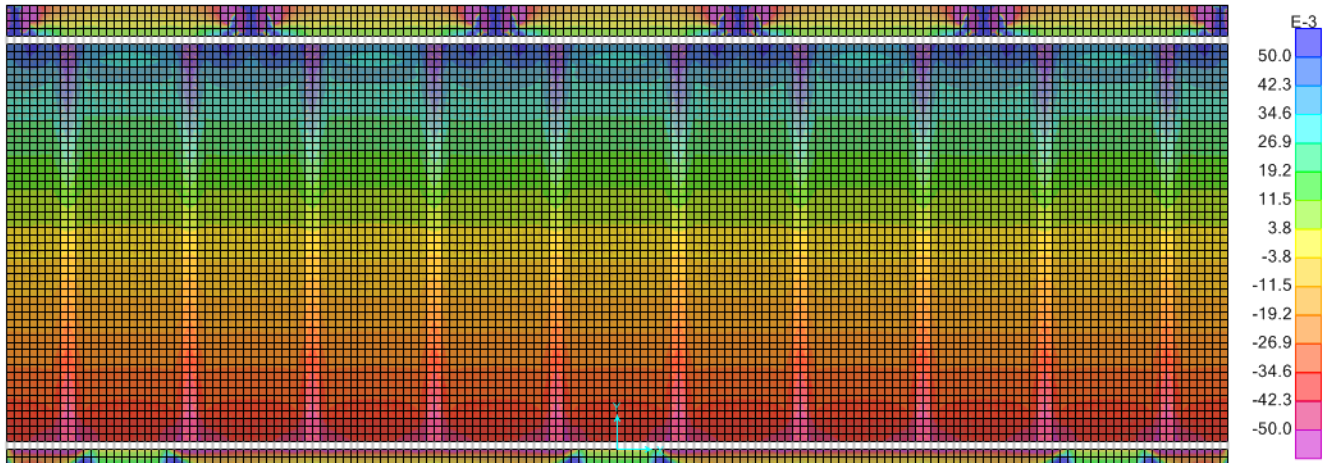

Figure 5-11: Shear V23 Contour for DEAD [k/in]

### Service Case

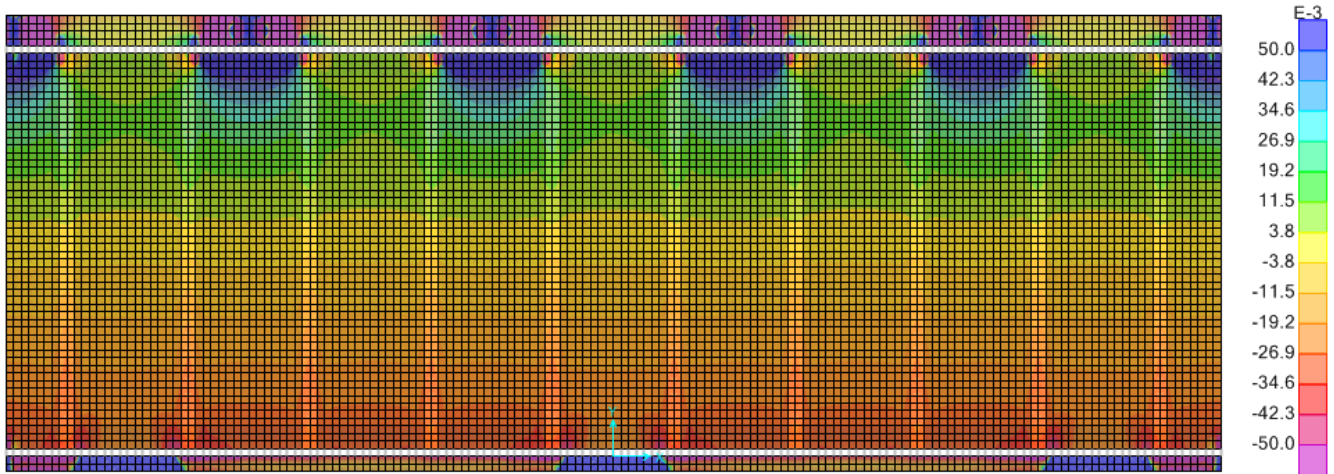
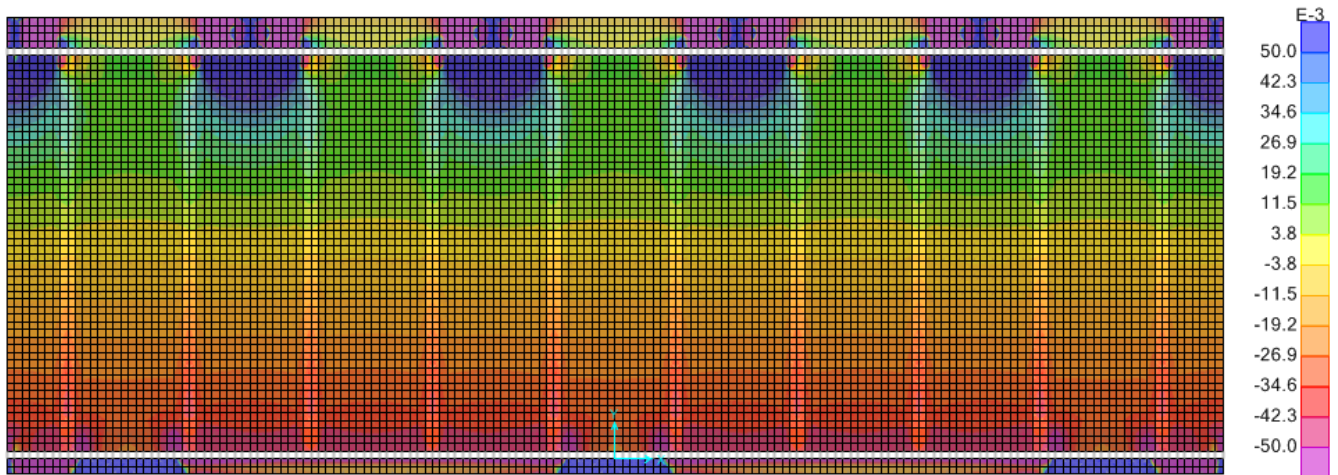

Figure 5-12: Shear V23 Contour for SDL [k/in]



**Figure 5-13: Shear V23 Contour for LL [k/in]**

Figures 5-14 and 5-15 show the shear in the floor along the grid line plank. Figures 5-16 and 5-17 show the shear in the floor along the mid-span plank and Figures 5-18 and 5-19 show shear in the spandrel beam. For all figures, the dead load shear for combinations is obtained from the construction case. For all floor plots,  $x=0$  is the wall side of the floor and  $x=312$  is the column side of the floor.

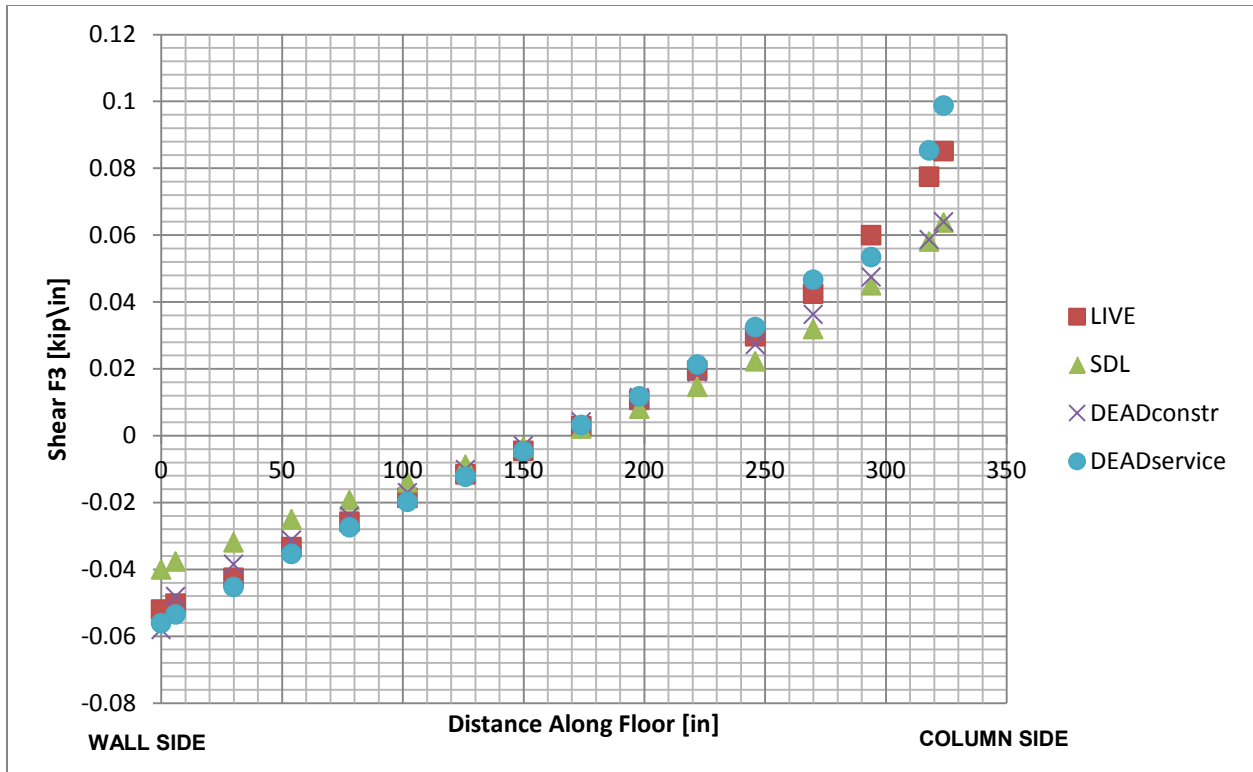

Figure 5-14: Shear F3 Plots for Floor Along Grid Line Plank for Load Cases

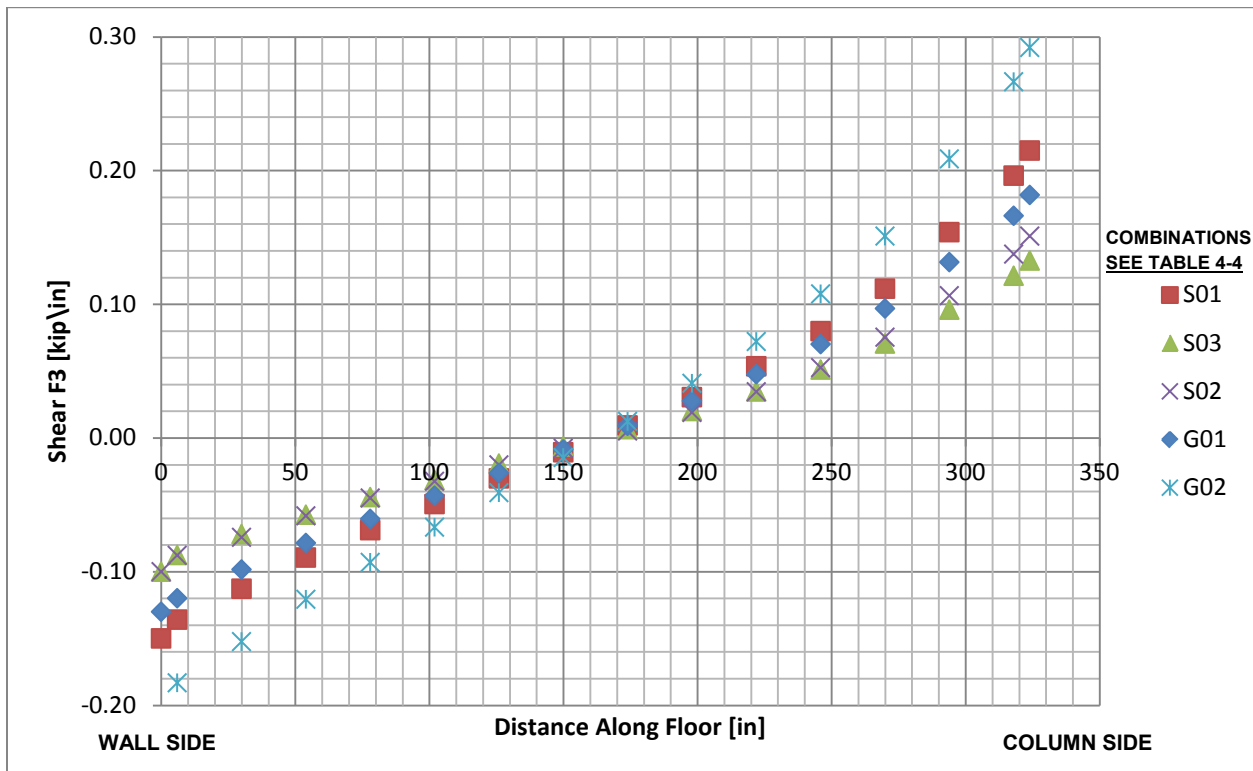

Figure 5-15: Shear F3 Plots for Floor Along Grid Line Plank for Load Combinations

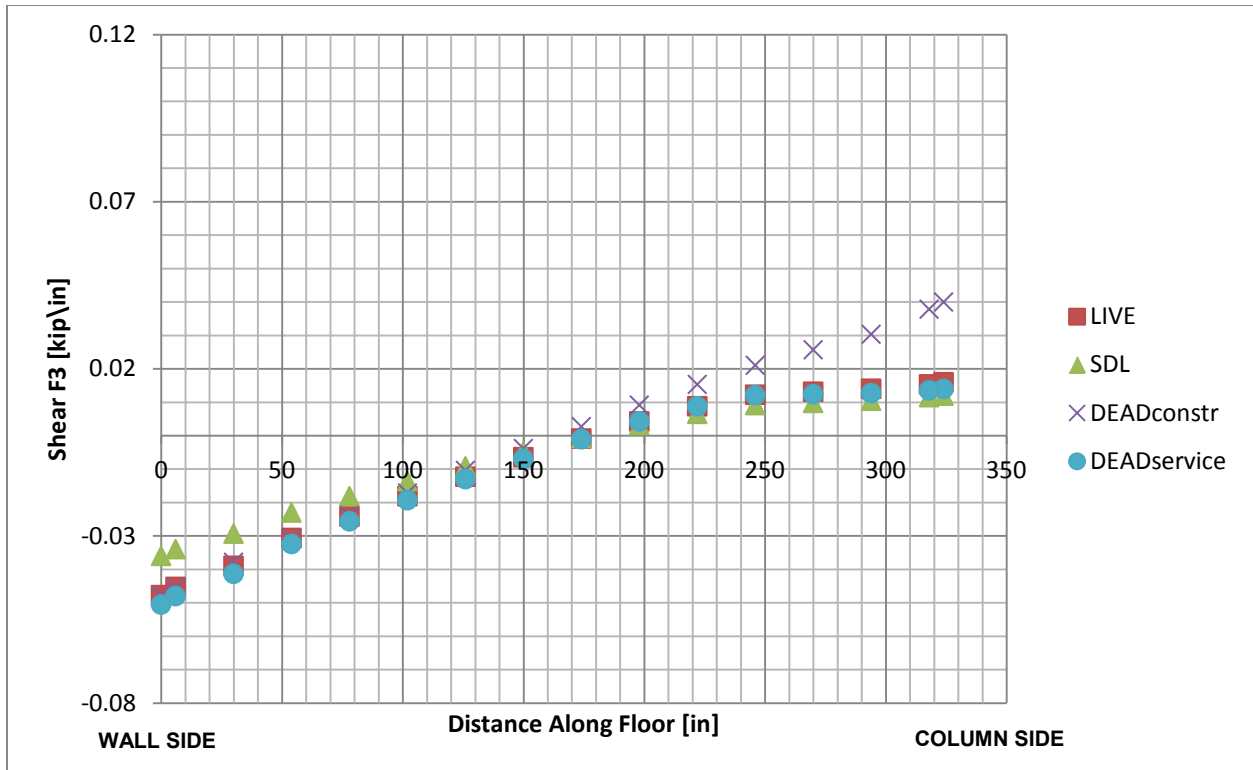

Figure 5-16: Shear F3 Plots for Floor Along Mid-Span Plank for Load Cases

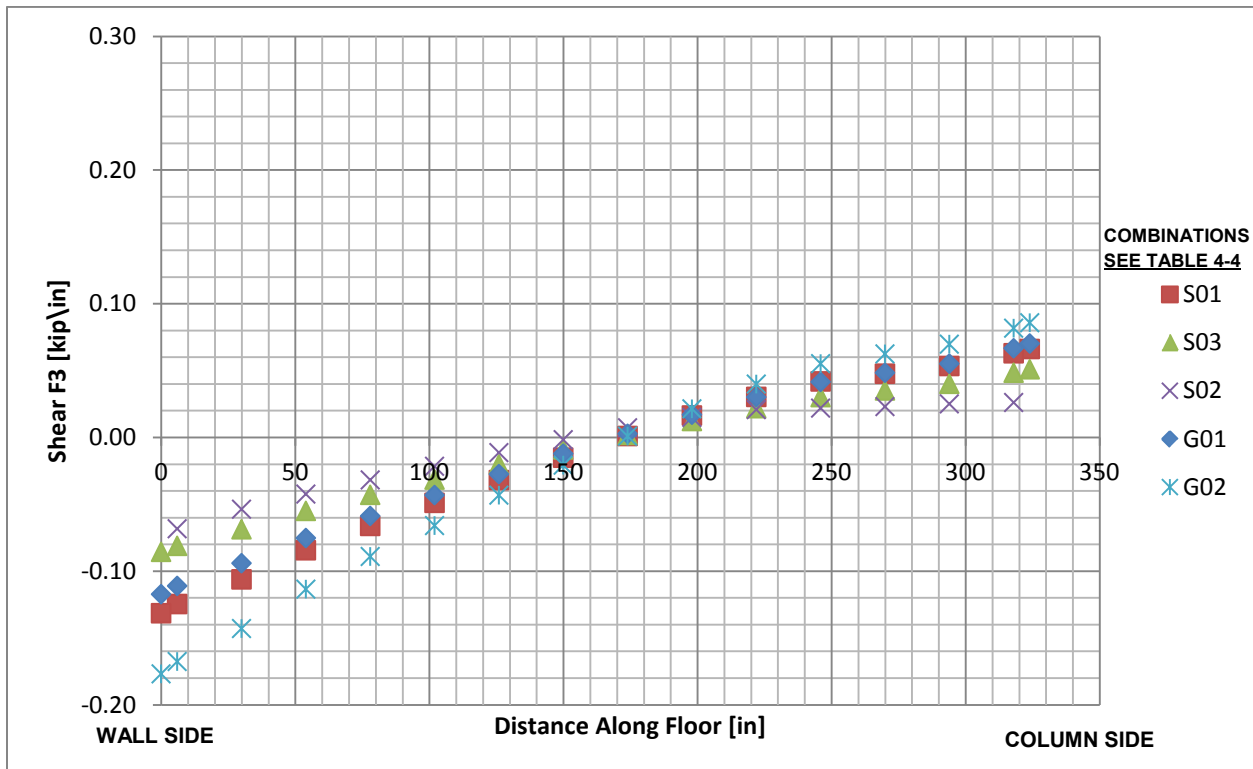

Figure 5-17: Shear F3 Plots for Floor Along Mid-Span Plank for Load Combinations

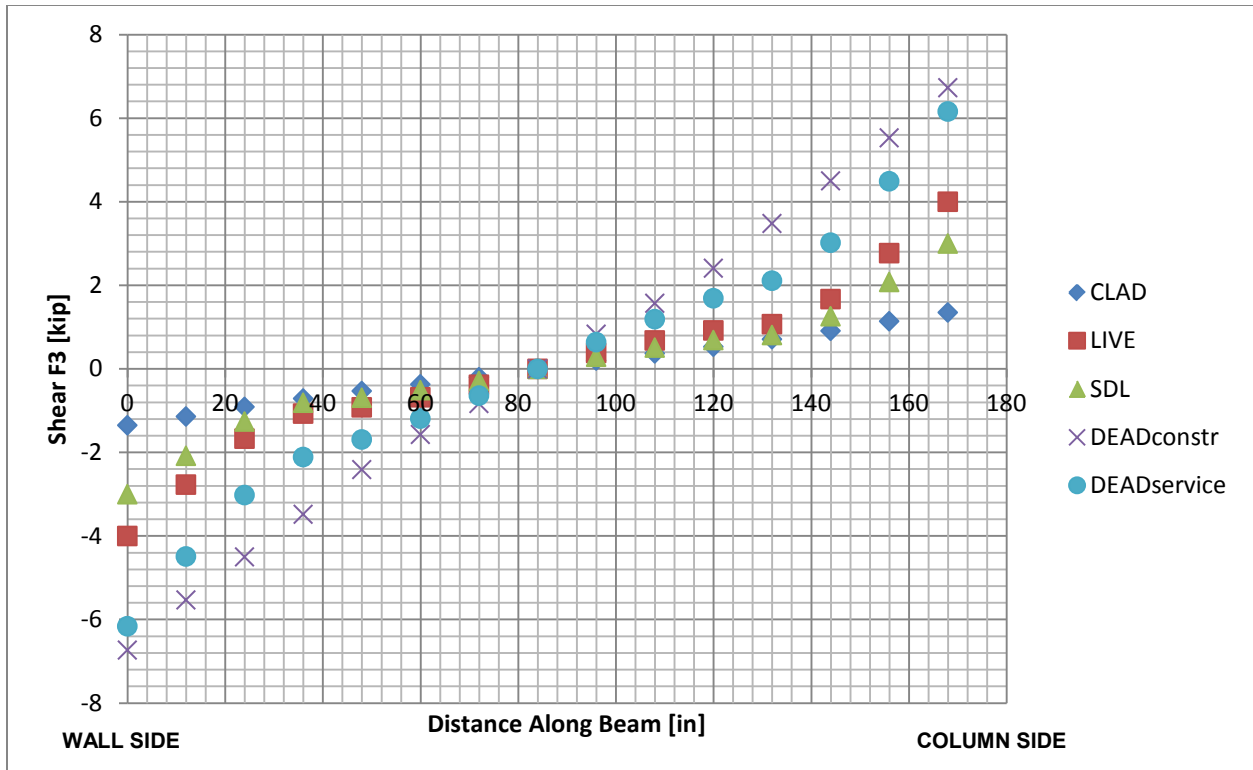

Figure 5-18: Shear F3 Plots for Spandrel for Load Cases

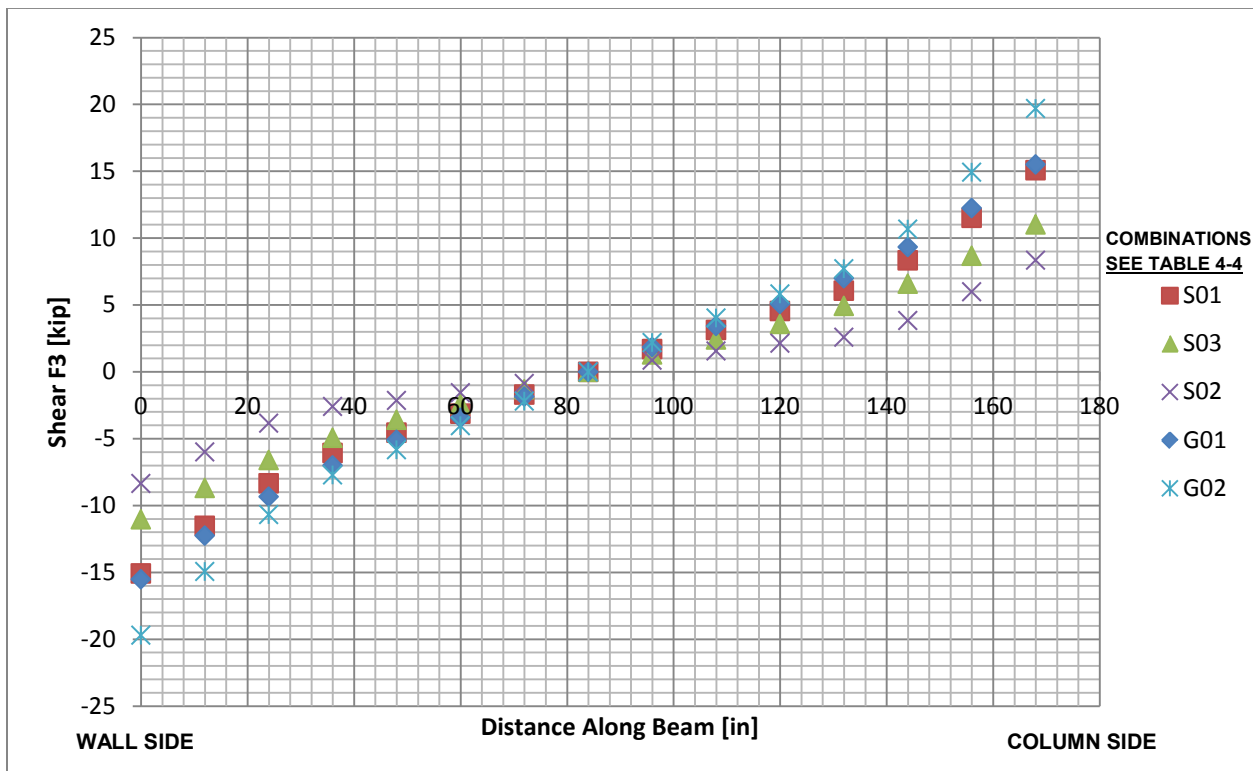

Figure 5-19: Shear F3 Plots for Spandrel for Load Combinations



## 5.6 Moment Demands

Contours and maximum values for moment are provided for load cases for the simply supported construction case and the moment connected service case in Figs 5-20 through 5-23. Figures 5-24 through 5-29 show the moments in the column strip, middle strip and in the spandrel. For all figures, the dead load moment for combinations is obtained from the construction model. For all floor plots,  $x=0$  is the wall side of the floor and  $x=312$  is the column side of the floor.

### Construction Case

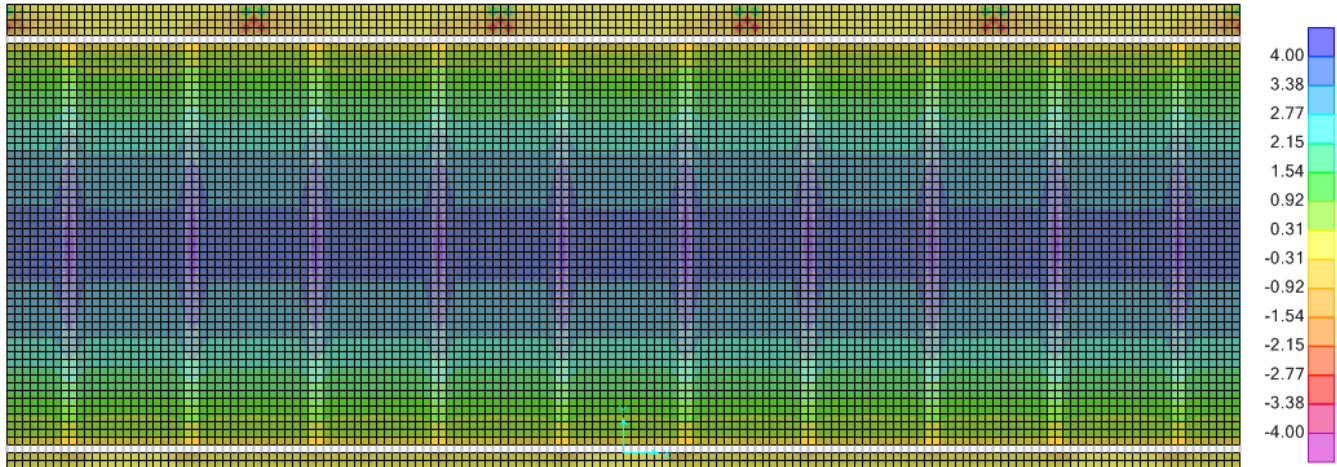

Figure 5-20: DEAD M22 Moment Contour for Construction Condition [k-in/in]

### Service Case

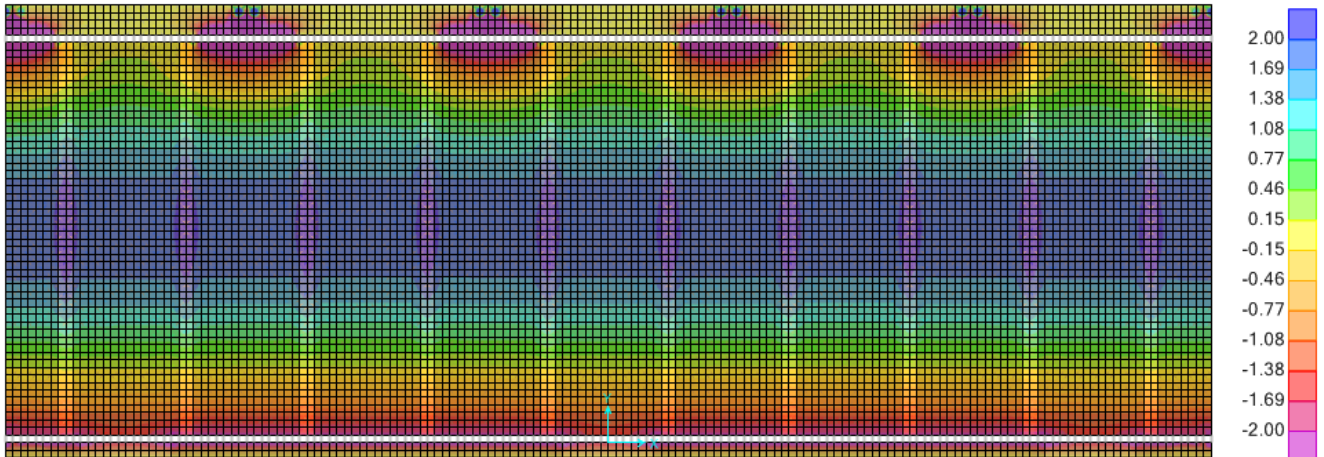

Figure 5-21: DEAD M22 Moment Contour for Service Condition [k-in/in]

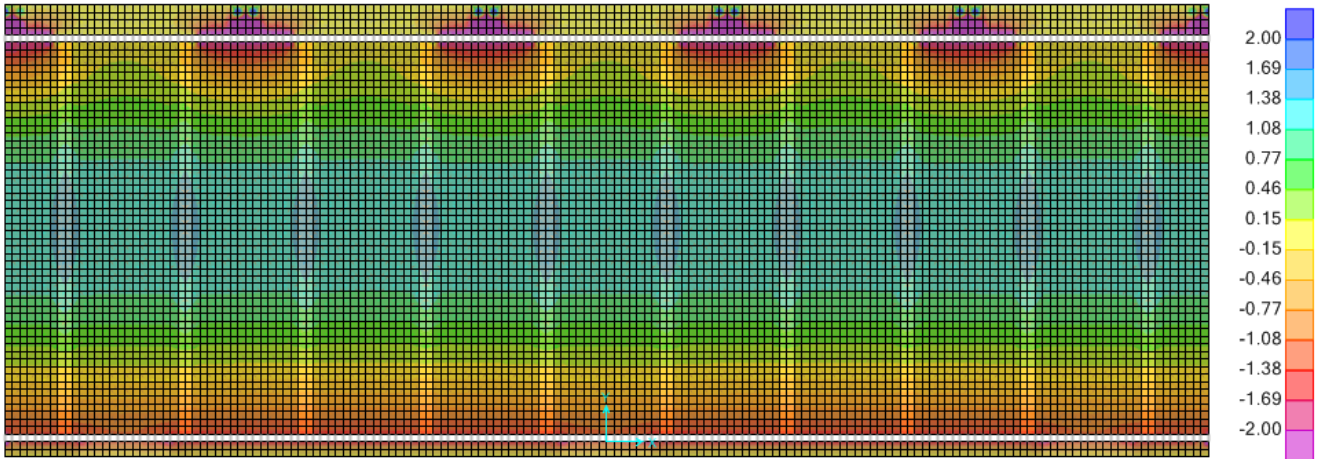

Figure 5-22: SDL M22 Moment Contour for Service Condition [k-in/in]

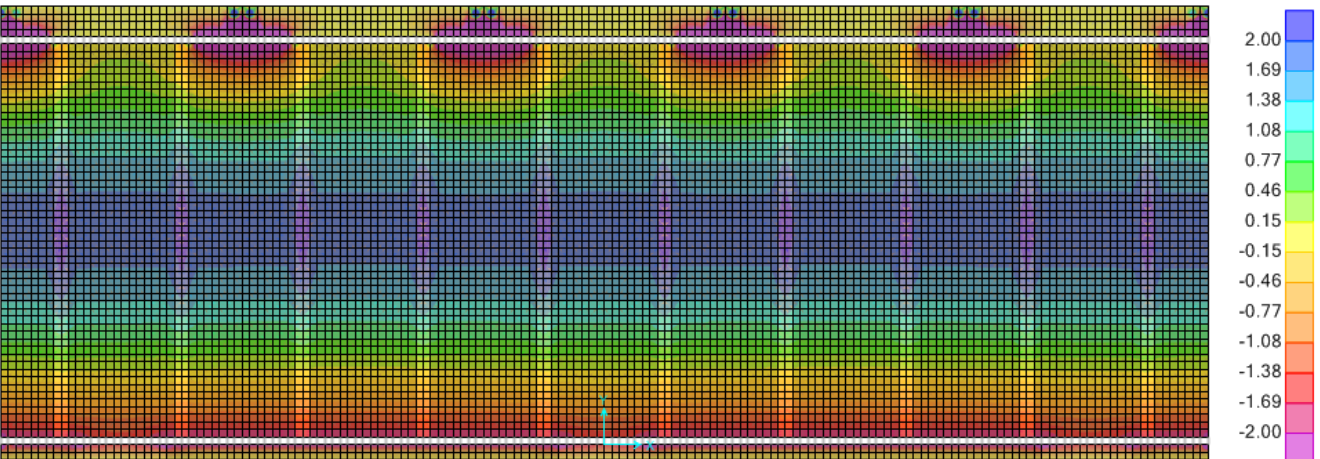

Figure 5-23: LL M22 Moment Contour for Service Condition [k-in/in]

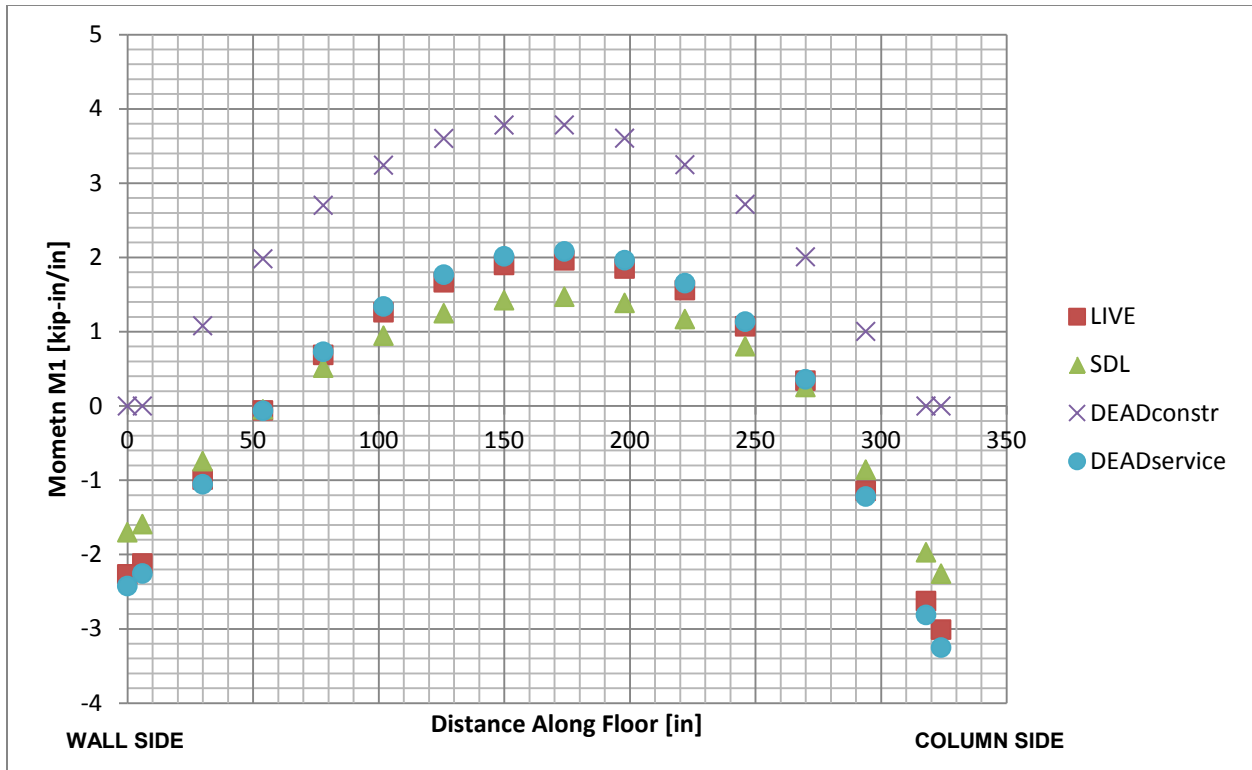

Figure 5-24: Moment M1 Plots for Floor Along Grid Line Plank for Load Cases

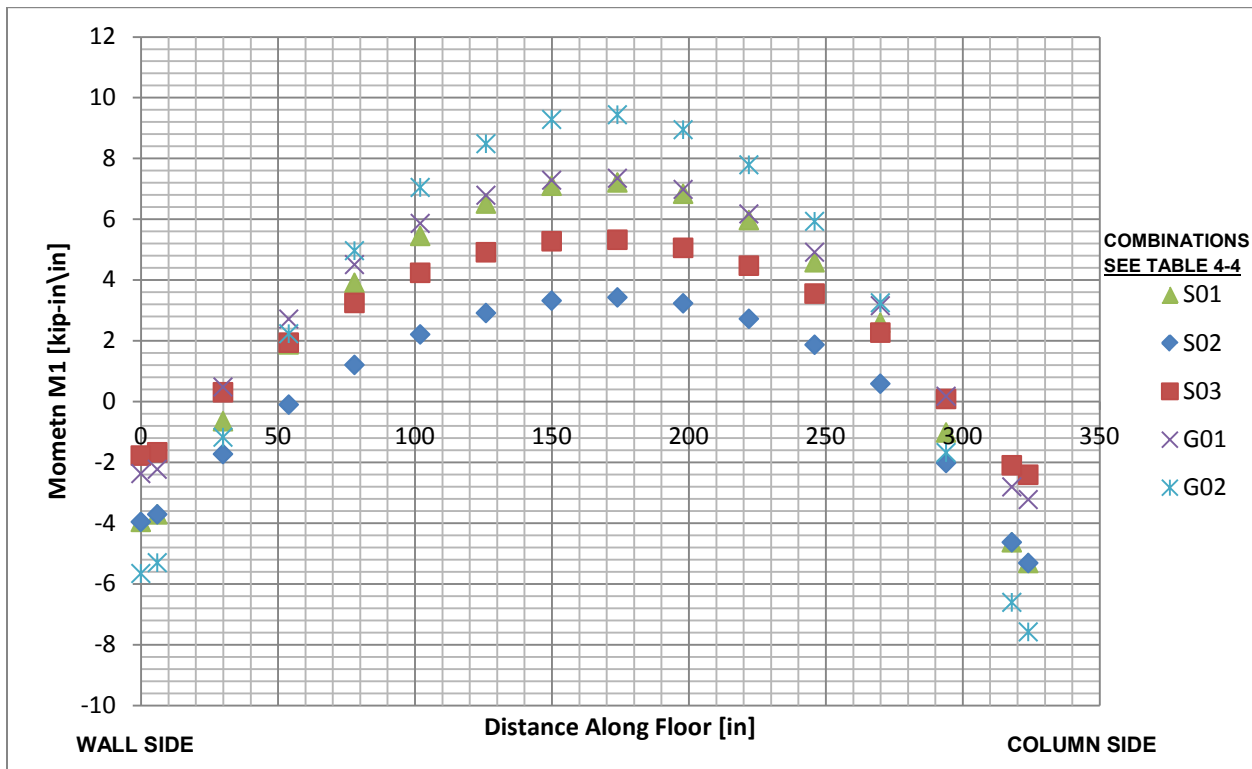

Figure 5-25: Moment M1 Plots for Floor Along Grid Line Plank for Load Combinations

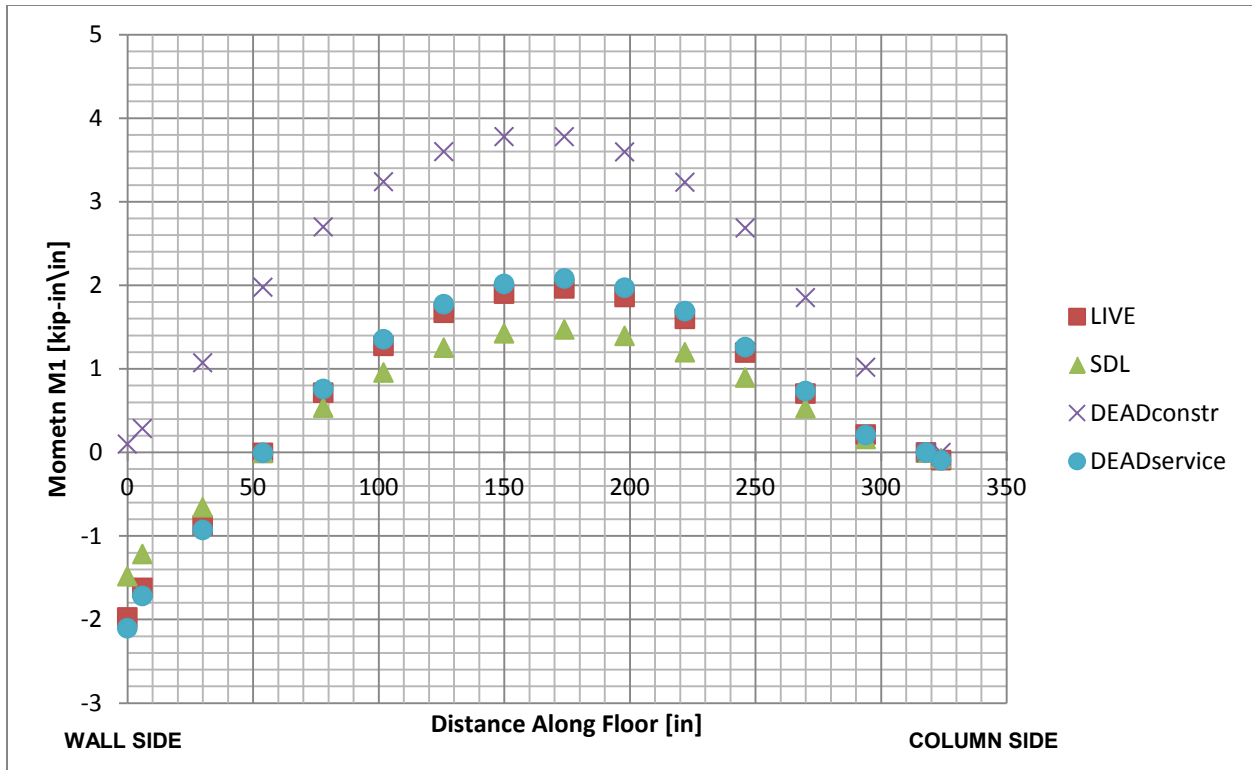

Figure 5-26: Moment M1 Plots for Floor Along Mid-Span Plank for Load Cases

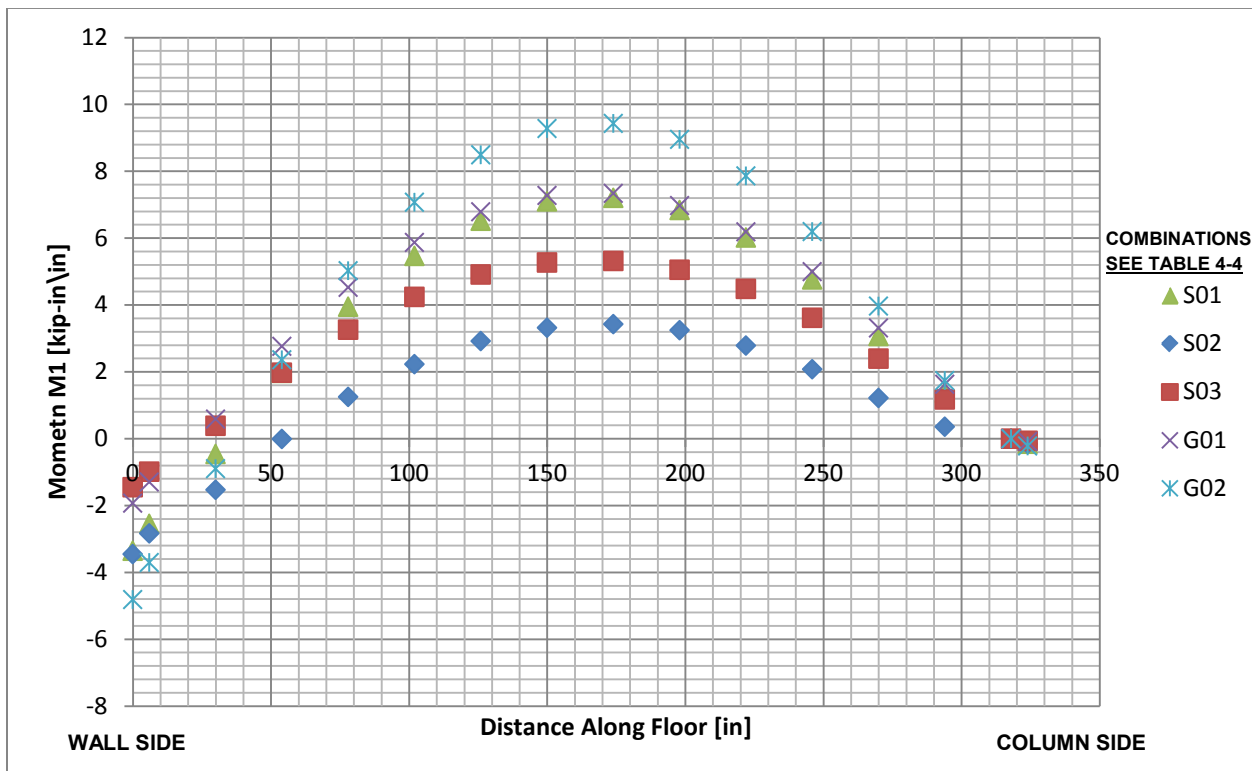

Figure 5-27: Moment M1 Plots for Floor Along Mid-Span Plank for Load Combinations

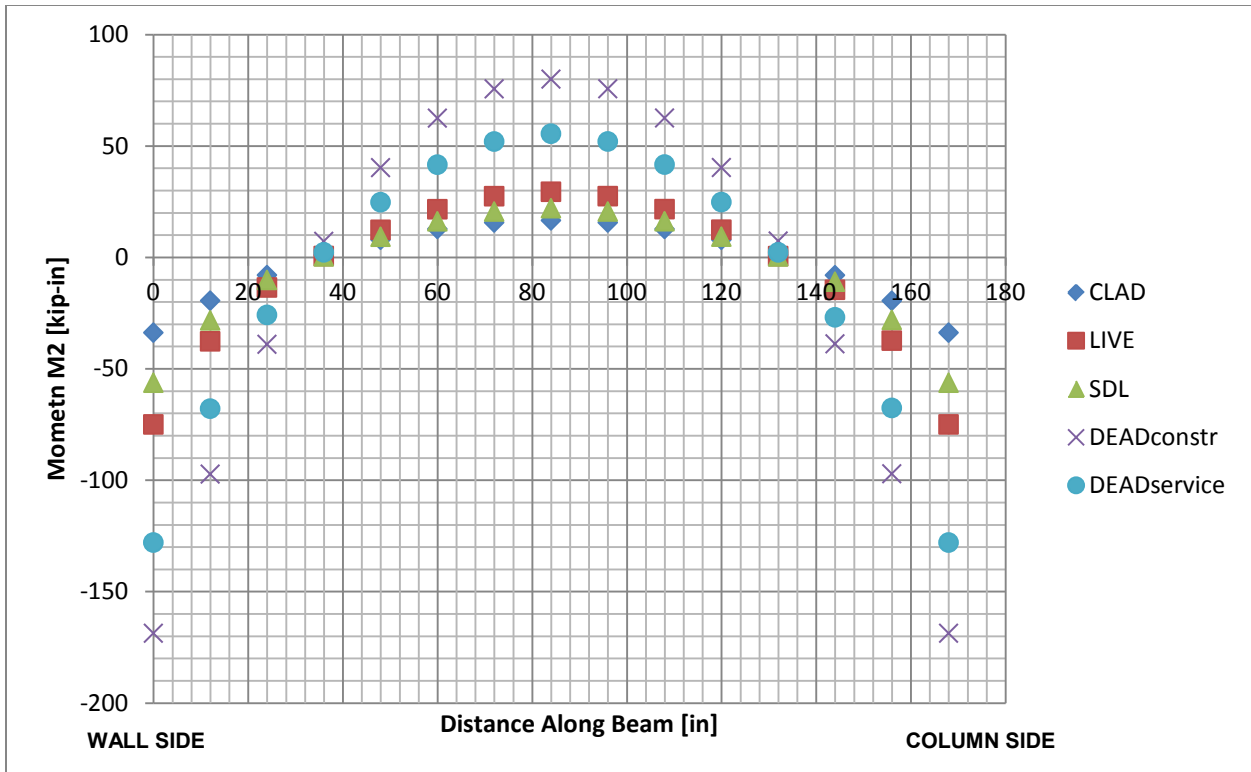

Figure 5-28: Moment M1 Plots Spandrel for Load Cases

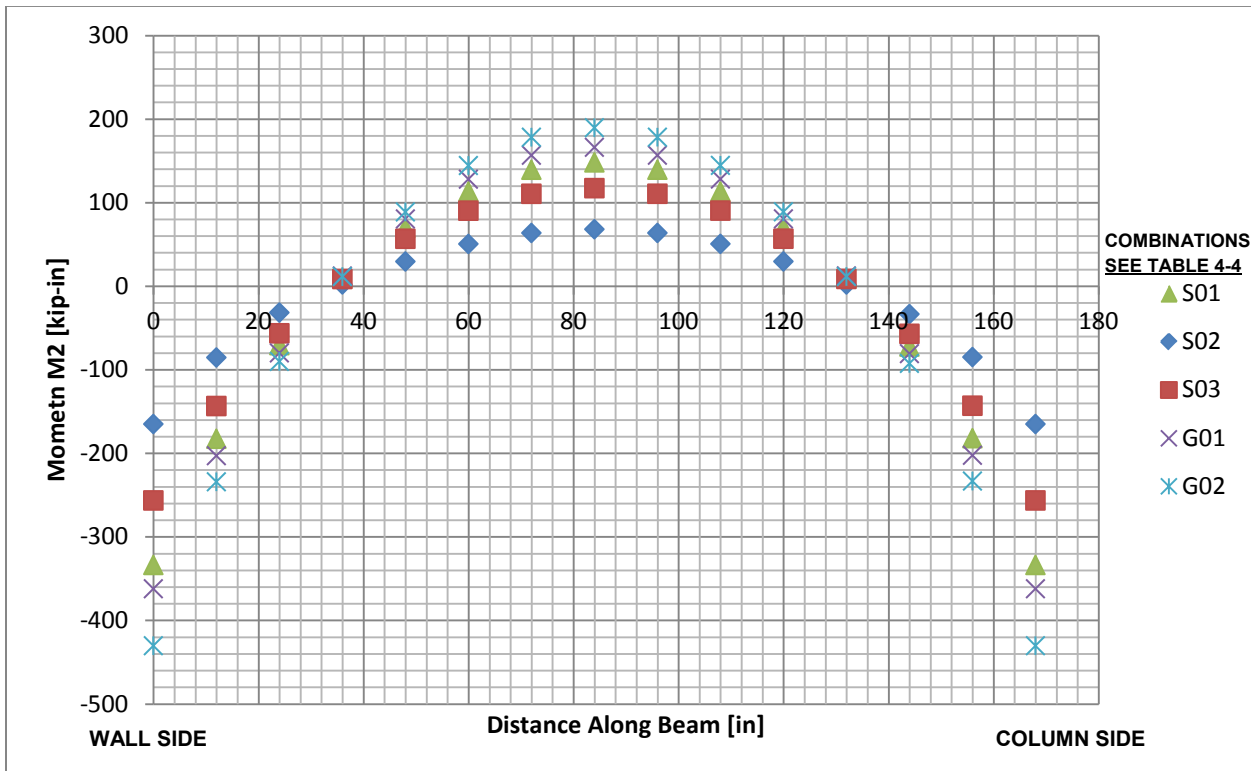

Figure 5-29: Moment M1 Plots for Spandrel for Load Combinations

## 5.7 Torsion and Connection Demands

The demand for the concrete spandrel is shown in Tables 5-3 and 5-4. The torsion is recorded at one beam width,  $B_{\text{beam}} = 2'-0"$ , away from the face of the column. Torsion moments within  $B_{\text{beam}}$  from the column face can be resolved with horizontal compression struts, similar to vertical shear within the one beam depth from the face of a support. Torsional moments within this dimension are not expected to govern the strength of the element and will need to be verified by physical testing.

Case/Combo	Torsion [kip-in]
DEAD	52.9
SDL	30.8
CLAD	-12.4
LL	41.1
S01	112.5
S02	59.6
S03	74.9
G01	157.5
G02	151.4

Table 5-3: Torsion Demand in Spandrel at  $B_{\text{beam}}$  From Face of Column

Case/Combo	Shear [kip]	Moment [kip-in]
S01	-8.3	-70.5
S02	-3.8	-31.5
S03	-6.60	-56.3
G01	-11.7	-98.6
G02	-10.7	-89.9

Table 5-4: Shear and Moment Demand for Spandrel Splice

## Section 6: Design Checks

### 6.1 Deflection Evaluation

The floor system deflections are evaluated from center to center of supports which is a length of 28'-6" = 342" inches. The following maximum deflections for the floor system were determined:

Individual Load Cases:

- $DEAD_{CONST} = 0.292''$
- $DEAD_{SERV} = 0.136''$
- $SDL_{SERV} = 0.095''$
- $LL_{SERV} = 0.125''$  ( $L/2,570 < L/360$  criteria, 14% of limit)

Combined Deflections:

- Total Instantaneous = 0.515"
- Sustained Loads = 0.236"
- Long Term = 0.472"
- Total + Long Term = 0.987" ( $L/350 < L/240$  criteria, 69% of limit)

The results of the analysis shows that the system satisfies both the live load and total instantaneous plus long term deflection criteria. The analysis performed assumes that no slip occurs between the mass-timber floors and topping slabs, no slip between the composite floors and concrete joints, and no slip between the concrete joints and vertical members providing rotational restraint. Rolling shear in the floors has also been assumed to be negligible due to detailing of the floor and large span to depth ratio of the system. Movement at any of these locations will increase deflections. Physical testing is necessary to determine sources of deflection not considered in this analysis. The results of the physical testing program will be used to calibrate analysis models for more precise predictions of system deflections. Should the actual deflections be larger than reflected in the analysis, camber can be considered to compensate for dead load and superimposed dead loads.

## 6.2 Vibration Evaluation

Evaluation of AISC DG11 Chapter 4: Design for Walking Excitation [4, 7]

- $a_p/g = P_0 e^{-0.35f_n} / \beta W$
- $P_0 = 65 \text{ lb}$
- $f_n = 7.32 \text{ Hz}$
- $\beta = 0.05$
- $W = wBL = (74 \text{ psf})(24.5 \text{ ft})(28.5 \text{ ft}) = 51,670 \text{ lbs}$
- $w = \text{expected load} = 42.5 \text{ psf (DEAD)} + 25.5 \text{ psf (SDL)} + 6.0 \text{ psf (LL)} = 74 \text{ psf}$
- $L = 28' - 6''$
- $B = C_j(D_s/D_j)^{1/4} L_j = 2.0(0.55)^{1/4}(28' - 6'') = 24.5 \text{ ft}$
- $a_p/g = (65 \text{ lb})e^{-0.35 \cdot 7.32 \text{ Hz}} / (0.05 \cdot 51,670 \text{ lbs}) = 0.00192 < 0.005 \text{ (38\% of limit)}$

Evaluation of AISC DG11 Chapter 6: Design for Sensitive Equipment [4, 7]

This approach estimates walking induced vibration velocity which is commonly used to evaluate the serviceability of sensitive equipment. This method can also be used to evaluate occupant comfort given the appropriate velocity thresholds [7].

- $V = U_v D_p / f_n$
- $U_v = 5,500 \text{ lb-Hz}^2$
- $D_p = 1.01 \text{e-5 inches/lb}$
- $f_n = 7.32 \text{ Hz}$
- $V = U_v D_p / f_n = (5,500 \text{ lb-Hz}^2)(1.01 \text{e-5 in/lb}) / (7.32 \text{ Hz})$   
 $= 7,590 \mu\text{in/sec} < 8,000 \mu\text{in/sec (95\% of limit)}$

The system satisfies both vibration criteria considered. It can be seen that the vibration design of the system controls with the given criteria, which may be too stringent as a slow walking pace could be considered. Physical testing of an entire bay will be necessary to confirm the dynamic behavior of this system.



### 6.3 Strength Checks

Floor Positive Bending: Reference Figure 2-10b

The floor strength is checked by assuming plane sections remain plane and limiting the stresses within a ply to NDS [8] permissible values. The choice of the NDS values over ANSI/APA PRG320 was made as this design is a ‘first principles’ approach for composite concrete CLT floor planks which does not have a standard in the United States. Concrete stresses are limited to values per ACI-318 [2].

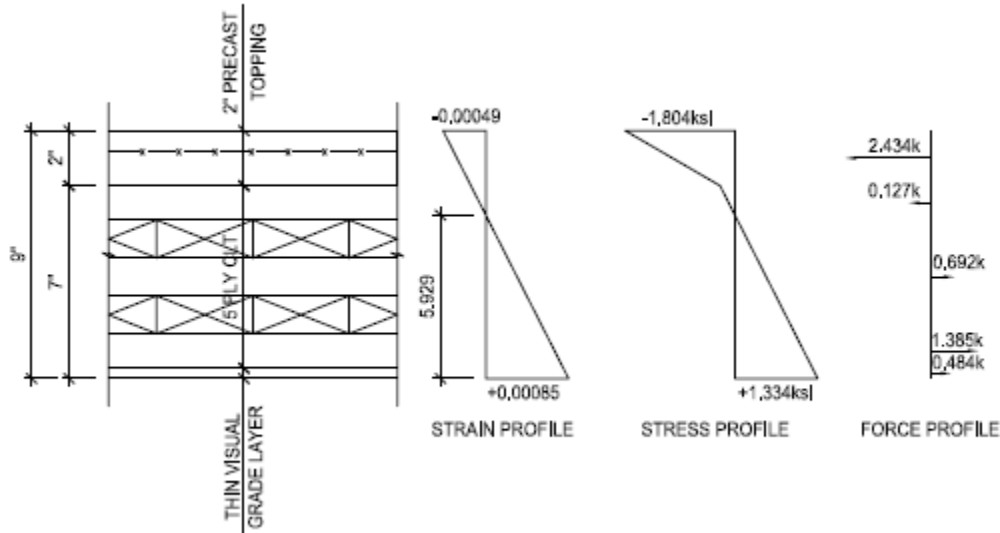

Category	Value	Unit	Notes
Curvature =	0.000161	/in	
N. Axis =	5.923	in	
Net Axial =	-0.001	kip	(OK)
Mn =	16.253	kip-in/in	
$\phi$ Mn =	13.815	kip-in/in	$\phi = 0.85$ per NDS
Mu =	7.350	kip-in/in	
Utilization =	0.532		(OK)

Layer ID	Material	B [in]	Th [in]	A [in <sup>2</sup> ]	Ybar [in]	Ec [ksi]	Strain	Stress [ksi]	Force [kip]	Moment [kip-in]
7	Concrete	1	2.000	2.00	8.00	3,644	-0.00033	-1.217	-2.434	5.06
6	Wood	1	1.250	1.25	6.38	1,400	-0.00007	-0.102	-0.127	0.06
5	Wood	1	1.375	1.38	5.06	0	0.00014	0.000	0.000	0.00
4	Wood	1	1.375	1.38	3.69	1,400	0.00036	0.503	0.692	1.55
3	Wood	1	1.375	1.38	2.31	0	0.00058	0.000	0.000	0.00
2	Wood	1	1.250	1.25	1.00	1,400	0.00079	1.108	1.385	6.82
1	Wood	1	0.375	0.38	0.19	1,400	0.00092	1.291	0.484	2.78

Notes:

1. Strength governed by 1.4D load combination due to 0.6 duration factor per NDS
2. Nominal bending stress in 1/2 SPF per NDS =  $0.6 \times 2.54 \times 0.875 \text{ksi} = 1.334 \text{ksi}$  (at limit)
3. Concrete stress is below ACI limits for compression members =  $0.8 \times 85 \text{f}'c = 2.720 \text{ksi}$

**Figure 6-1: Composite Floor Positive Bending Strength**

Floor Negative Bending: Reference Figure 2-10d

The floor strength is checked by assuming plane sections remain plane and limiting the stresses within a ply to NDS [8] permissible values. Reinforcing stresses are limited to values specified by ACI-318 [2]. Plies in tension are not considered as they may not be developed at the critical section, only the steel reinforcement is considered for tension strength.

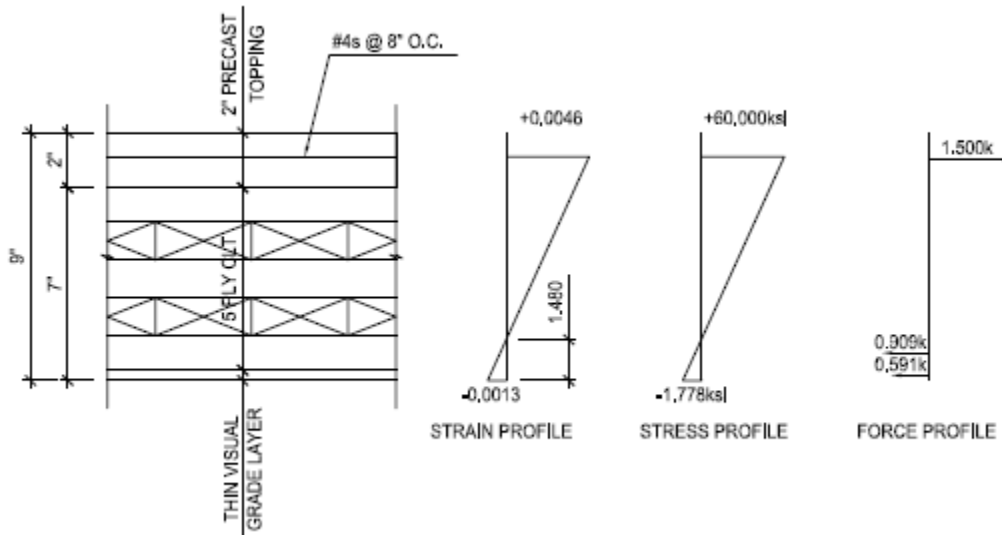

Category	Value	Unit	Notes
Curvature =	0.000747	/in	
N. Axis =	1.695	in	
Net Axial =	0.000	kip	(OK)
Mn =	10.793	kip-in/in	
$\phi$ Mn =	9.390	kip-in/in	$\phi = 0.87$ per ACI
Mu =	7.580	kip-in/in	
Utilization =	0.807		(OK)

Layer ID	Material	B [in]	Th [in]	A [in <sup>2</sup> ]	Ybar [in]	Ec [ksi]	Strain	Stress [ksi]	Force [kip]	Moment [kip-in]
7	Steel	N/A	N/A	0.03	7.88	29,000	0.00462	60.000	1.500	9.27
6	Wood	1	1.250	1.25	6.38	0	0.00350	0.000	0.000	0.00
5	Wood	1	1.375	1.38	5.06	0	0.00252	0.000	0.000	0.00
4	Wood	1	1.375	1.38	3.69	0	0.00149	0.000	0.000	0.00
3	Wood	1	1.375	1.38	2.31	0	0.00046	0.000	0.000	0.00
2	Wood	1	1.250	1.25	1.00	1,400	-0.00052	-0.727	-0.909	0.63
1	Wood	1	0.375	0.38	0.19	1,400	-0.00113	-1.577	-0.591	0.89

Notes:

1. Strength governed by 1.2D+1.6L since reinforcing controls,  $\phi=0.87$  due to strain < 0.005.
2. Nominal bending stress in 1/2 SPF per NDS =  $0.8 \times 2.54 \times 0.875 \text{ksi} = 1.778 \text{ksi}$  (at limit)

**Figure 6-2: Composite Floor Negative Bending Strength**

Composite Floor Horizontal Shear Demand: Reference Figure 2-10b

The horizontal shear demand is governed by  $1.2D+1.6L$  [1]. This horizontal shear demand is reported for consideration in selecting a composite shear connector system to connect the CLT planks and concrete topping slab. The strength of the CLT element is checked to show that the overall system can resist the horizontal shear demand.

*Horizontal Shear Demand*

Item	Value	Units	Notes
$V_u =$	0.29	kip/in	from analysis
$Q =$	1.43	$\text{in}^3/\text{in}$	parallel plies only, lowest perpendicular ply
$I =$	29.2	$\text{in}^4/\text{in}$	parallel plies only
$V_u Q/I =$	14.2	psi	horizontal shear demand

*CLT Plank Check*

$\phi V_{n, \text{rolling}} =$	77.80	psi	$CLTHB_s = 0.75 \cdot 0.8 \cdot 2.88 \cdot 45 \text{psi}$
Utilization	0.18		OK

**Figure 6-3: Composite Floor Horizontal Shear Design**

Floor Negative Bending Moment Connection: Reference Figure 2-10d

Only the compression force of the moment couple needs to be checked for this connection as the tension reinforcement is shown to be satisfactory in the negative bending check. The moment connection is controlled by 1.2D+1.6L combination [1]. The connection is checked for two load transfers, compression in the mass-timber to a steel plate via shear in the mass-timber and compression in the steel plate to concrete joint via masonry screw shear and projected area bearing on the grouted strip.

*Shear Transfer to Plate*

Item	Value	Units	Notes
Mu =	7.58	kip-in/in	from analysis
d =	7.875	in	
Vu =	0.963	kips/in	
Lplate =	6.000	in	
$\phi$ Vn, wood =	233	psi	NDS, = 0.75*0.8*2.88*135psi
$\phi$ Vn, conn =	1.400	kips/in	
Utilization =	0.69		OK

*Anchor Design of Compression Force*

Item	Value	Units	Notes
Mu =	7.58	kip-in/in	from analysis
Sanchor =	4	in	
Mu/anchor =	30.32	kip-in	
d =	8.00	in	
Vu/anchor =	3.79	kips	
$\phi$ Vn/anchor =	1.80	kips	0.75*2.4kips (1/4" Hilti KWIK-CON II)
Abear =	1.15	in <sup>2</sup>	Abear = 2x bolt head and plate area
$\phi$ Rn,bear =	3.18	kips	ACI, = 0.65*0.85*fc
$\phi$ Rn,total =	4.982	kips	Screw shear plus bearing
Utilization =	0.76		OK

Notes:

1. Masonry screws can support the expected loading including vibration demands. Slip may occur and grout engaged in bearing at full service loads or ultimate loads.
2. Substitute 3/8" diameter KWIK-HUS EZ connectors for wider spacing or 100% load transfer through the steel shear connectors.

**Figure 6-4: Floor Negative Bending Moment Connection**

Concrete Ledge Strength Check: Reference Figure 2-10c

The concrete ledge is checked for the dead plus construction live load condition. The imposed loads are transferred through a diagonal compression strut through the grouted strip connection.

*Wood Bearing on Ledge, Construction Case*

Item	Value	Units	Notes
Vu =	1.5	kip/ft	1.2D+1.6LLconst(20psf)
$\phi F_{C_{perp}}$ =	0.403	ksi	NDS, = 0.90*0.8*1.67*335psi
Abrg =	24	in <sup>2</sup> /ft	(2" bearing design based on allowed tolerance)
$\phi R_n$ =	9.672	kips/ft	
Util,Brg =	0.16		OK

*Concrete Ledge Shear and Bending, Construction Case*

Item	Value	Units	Notes
Vu =	1.5	kip/ft	1.2D+1.6LLconst(20psf)
d,dba =	2.00	in	
$\phi V_c$ =	2.55	kips/ft	
Util,V =	0.59		OK
Mu =	11.25	kip-in/ft	7" moment arm to beam stirrup
As =	0.2	in <sup>2</sup>	
AsFy =	12	kips	
a =	0.24	in	ACI, compression block depth
$\phi M_n$ =	20.33	kip-in/ft	ACI, $\phi = 0.9$
Util,M =	0.55		

*Inclined Shear at Column End of Column Strip, Imposed Load, Ref Figure 2-9*

Item	Value	Units	Notes
Vu =	3.6	kip/ft	From analysis, ultimate imposed diagonal shear
A <sub>bear</sub> =	3.72	in <sup>2</sup>	A <sub>bear</sub> = 2x bolt head, 3 bolts per plate
$\phi R_{n,bear}$ =	10.28	kips	ACI, = 0.65*0.85*f <sub>c</sub>
S <sub>max</sub> =	34.3	in	= typical spacing, OK

**Figure 6-5: Concrete Ledge & Shear Connection Strength Check**

Concrete Spandrel Strength Check: Reference Figure 2-11

The concrete spandrel is checked with S-Concrete Version 11.00 by S-Frame Software:

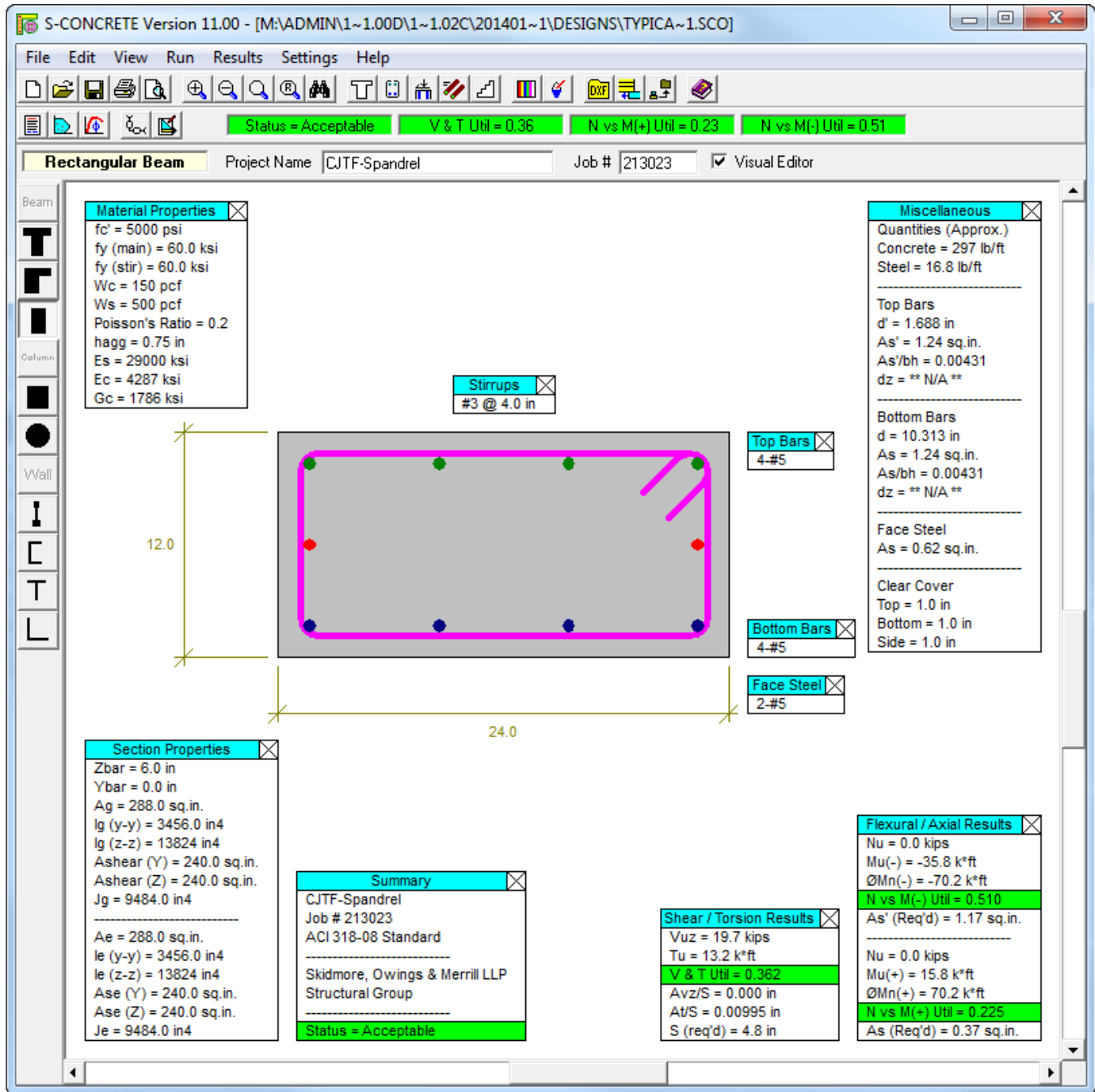

Figure 6-6: Spandrel Strength Check

Concrete Spandrel Splice Check: Reference Figure 2-11

The concrete spandrel splice is designed to transfer the required shear forces and to develop the required strength of the beam at the support.

*Design Via ACI Strut and Tie Method*

Item	Value	Units	Notes
V <sub>u</sub> =	11.7	kips	from analysis
V <sub>u,Incl</sub> =	19.82	kips	1.69x due one strut at angle
A <sub>strut</sub> =	10.50	in <sup>2</sup>	4 struts, one per bar
V <sub>u</sub> /A <sub>strut</sub> =	1.89	ksi	
φP <sub>c</sub> =	2.25	ksi	ACI, =0.75*0.6*1.0*5ksi
Util =	0.84		OK

*Design Welds for Bending, Develop Bars*

Item	Value	Units	Notes
φT <sub>n, #5</sub> =	16.74	kips	tension capacity of bar
D <sub>w,eff</sub> =	0.125	in	=.4(Radius of Bar)
L <sub>weld,eff</sub> =	7	in	= 2sides(L <sub>w</sub> -2D <sub>w</sub> )
φR <sub>nweld</sub> =	27.56	kips	AISC, =0.75*.6*70ksi*L <sub>w</sub> *D <sub>w</sub>
Util =	0.61		OK

*Design Bolts for Bending, Develop Actual Moment W/Slip Critical Bolts*

Item	Value	Units	Notes
dbolt =	0.625		A490 bolts
Preten/bolt =	24	kips	
Pretension =	48	kips	2 bolts / bar
φR <sub>n</sub> =	16.14	kips	AISC, =1.00*0.35*1.13*0.85
R <sub>u</sub> =	13.32	kips	M <sub>u</sub> / (dist between bolts X # of bars)
Util =	0.83		OK

**Figure 6-7: Spandrel Splice Strength Check**

Wall Bending Strength Check: Reference Figure 2-12a

The wall capacity is checked against the floor negative bending capacity. The strength is based on the strength of the steel reinforcing dowels only. A resistance factor of 0.90 is assumed.

*Design for Floor Negative Bending Capacity*

Item	Value	Units	Notes
Mu =	9.4	kip-in/in	floor negative bending capacity
dbars =	8.5	in	CL to CL of vertical bars
AsFy =	12	kips	
Sbars =	16	in	bar spacing along wall
$\phi$ Mn =	5.74	kip-in/in	= 0.90AsFySbars, capacity reacting upward or downward
Util =	0.82		= Mu/(2* $\phi$ Mn), OK

**Figure 6-8: Wall Bending Strength Check**

Column Bending Strength Check: Reference Figure 2-12a

The column capacity is checked against the analysis results. The strength is based on the strength of the steel reinforcing dowels only. A resistance factor of 0.90 is assumed.

*Design for Actual Demand from Model*

Item	Value	Units	Notes
Mu =	500	kip-in	from analysis
dbars =	19.5	in	CL-CL of extreme row of bars only
nbars =	5		
Ab =	0.2	in <sup>2</sup>	
AsFy =	60	kips	
$\phi$ Mn =	1053	kip-in	= 0.90AsFydbars, capacity reacting upward or downward
Util, bars =	0.24		= Mu/(2* $\phi$ Mn), OK
Col Stress =	0.217	ksi	Mu/S Stress
$\phi$ Fb =	1.778	ksi	NDS, =0.8*2.54*0.875ksi
Util, col =	0.12		

**Figure 6-9: Column Bending Strength Check**



## Section 7: Conclusions

The system as shown appears to be able to satisfy the intent of the code with reasonable element sizes and connection details. Additional research related to the fire resistance of the system and physical testing will be required to confirm these findings.

### 7.1 Review of Studies

The gravity framing components of the concrete jointed timber frame system were analyzed and designed for typical high-rise apartment geometry. These components included mass-timber floor planks with composite concrete toppings, reinforced concrete joints and spandrel beams, and mass-timber shear walls and columns. The geometry considered was a 29'-0" lease span and 8'-6" floor to ceiling height with mass-timber shear walls along one edge of the floor and mass-timber columns at 16'-0" on center at the other end of the floor. The system was analyzed and evaluated for deflections, vibrations, and strength of the components.

### 7.2 Review of System Performance

The analysis documented in this report suggests that the concrete jointed timber frame system is a relatively stiff and strong floor framing system which may be prone to vibrations due to walking excitation. The stiffness of the system to satisfy deflections will be governed by total immediate plus long-term deflections. The system as documented is predicted to deflect to approximately 70% of that deflection limit. The strength of the system is expected to be satisfactory based on the calculated demands and provided strength calculations. The system is expected to be near the selected vibration criteria which may be too stringent for residential occupancies. Less stringent vibration criteria might allow for more economical member designs. These predictions must be verified by physical testing as recommended below.

### 7.3 Verification of Assumptions

The following assumptions have been made in the design of the system as shown. Each of these assumptions must be verified by physical testing. Potential tests which could confirm these assumptions are shown in Appendix 2.

- The shear strength of the wood was assumed to be less than the shear strength of the epoxy connections.
- Moisture changes in the mass-timber and shrinkage in the concrete were assumed to have a negligible impact on system strength. Additional deflections were assumed to be captured in the assumed 2.0 long term deflection multiplier.
- No slip was assumed between the mass-timber and concrete topping.
- Additional deformations due to rolling shear deformations in the secondary plies were assumed to be negligible due to the detailing and geometry of the system.
- Losses in floor stiffness due to the lap splice of top reinforcing bars at the ends of floor planks were assumed to be negligible.
- The connection grout must be non-shrink or use shrinkage compensating admixtures.
- No slip was assumed at the interface of the concrete joints and vertical timber elements.
- Fire resistance was considered from a conceptual perspective only. Fire resistance of the details shown must be evaluated by a fire engineer and verified by physical testing.

# Appendix 1: Contractor Review Summary

## A1.1: Contractor Review Summary

The following design considerations were highlighted in a review of the original system by contractors knowledgeable with high-rise construction:

- The system should use 'column trees' to minimize pick counts. The precast beam splices shown have been designed to achieve this.
- Field assembly of precast beam and timber column trees adds cost. Beams and columns within the tree should be connected off site. Column joint shown in Figure 2-7 indicates a shop connection. Columns would be spliced approximately 4'-0" above the floor, similar to columns in a structural steel building.
- The acoustic concrete topping adds cost. Make this topping structural and composite to offset the cost of the topping with timber plank thickness savings.
- The ceiling finishes add significant cost. The system as shown uses a thin visual grade which is structural and exposed, offsetting this cost.
- Routing of electrical conduit within the floor thickness is not as simple as a cast-in-place concrete slab. The revised system could route conduit within the top ply of the mass-timber floor and partially within the concrete topping without compromising the structural performance.
- Fireproofing of connections if required will add cost and needs to be considered.
- The floor-to-floor height had to be taller for the original system. The composite topping and exposed visual grade approach reduces the ceiling sandwich dimension. This will reduce costs due to floor-to-floor height differences.
- The composite-timber system will save on foundations due to less total gravity load. The system as shown in this report is approximately 5% lighter due to weight savings in the concrete joints.

## Appendix 2: Potential Testing Program

The analysis and design of the system as documented required a number of assumptions which are documented in Section 7.3. A physical testing program will be required to verify these assumptions prior to implementation of the system in the market. Structural researchers experienced in mass-timber will need to determine the necessary testing programs to verify the assumptions and behavior of the proposed system. The structural researcher should consider the tests discussed below. Detailed finite element analysis of the structural details selected for testing should be included as part of the testing program. The details shown in Section 2.3 and Appendix 3 should be considered for testing by the structural researcher.

### A2.1: Floor Composite Action Test

The composite behavior of the mass timber plank and precast concrete topping slab must be verified. A full scale load test of the composite timber floor planks is recommended to determine the strength, stiffness, and long-term behavior. Two types of tests should be included: a simply supported floor as shown in Figure A2-1 below and a span with fixed end supports in order to verify composite action under negative bending. Multiple tests with different types of horizontal shear connectors are recommended. Refer to Appendix 3 for additional shear connector details which could be tested.

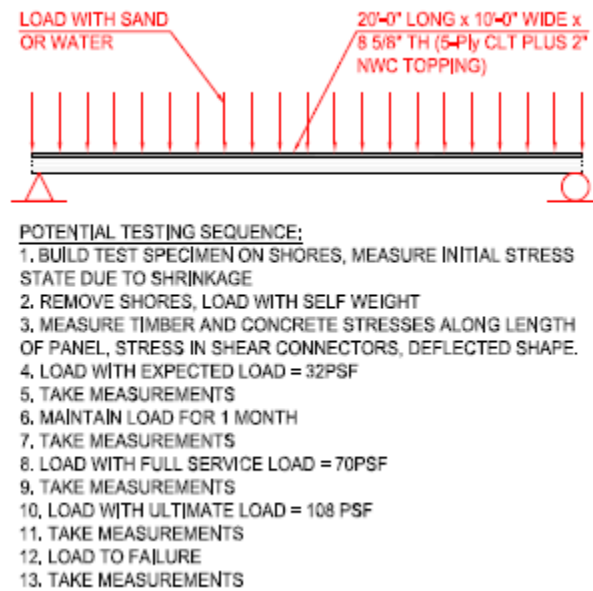
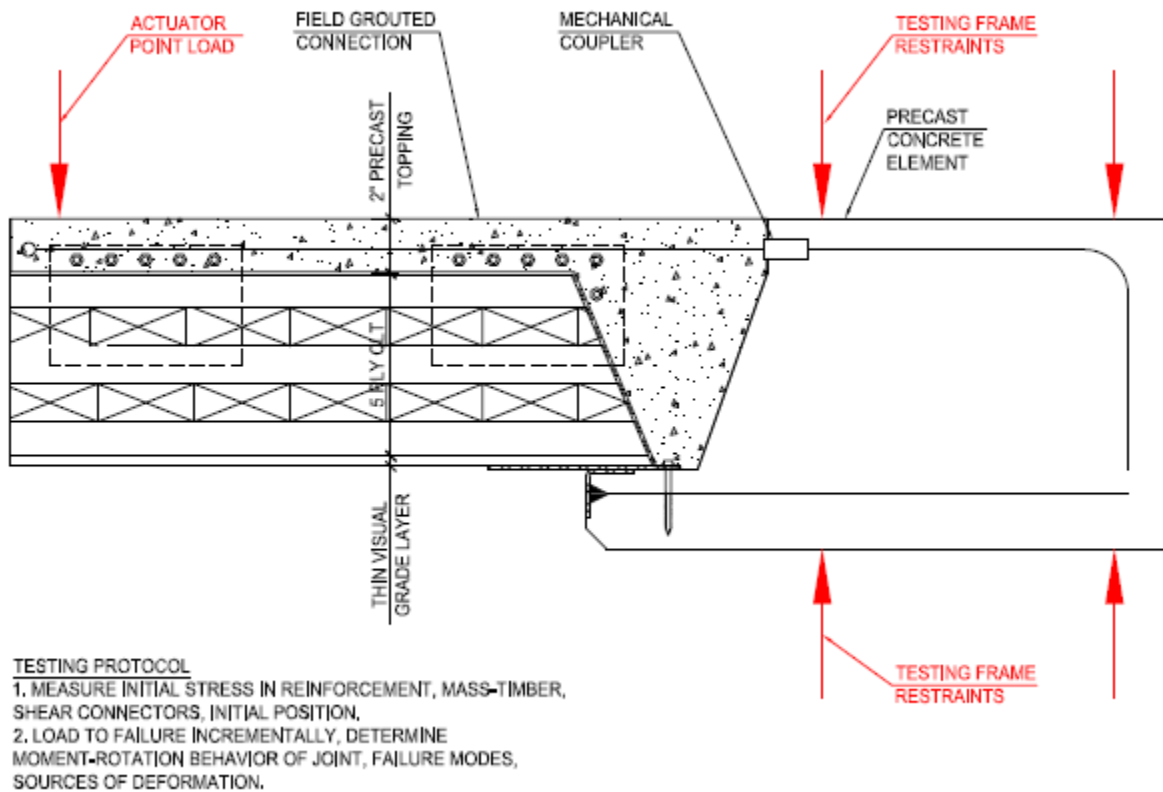

Figure A2-1: Floor Composite Action Test

## A2.2: Floor Moment Connection Test

The moment connection of the composite floor plank to the reinforced concrete elements is essential to the system behavior. A series of full scale load tests of this connection are recommended to determine the strength and stiffness characteristics. Multiple tests with variations in the connection details are recommended. Refer to Appendix 3 for additional details which could be tested.



**Figure A2-2: Floor Moment Connection Test**

### A2.3: Column Moment Connection Test

The moment connection of the reinforced concrete elements to the vertical timber elements must be verified for strength and stiffness. The connection of the column has a higher load demand compared to the wall and thus is recommended for a full scale load testing. The results of this test could be extrapolated to design the similar wall moment connections or additional wall testing similar to the column could be provided.

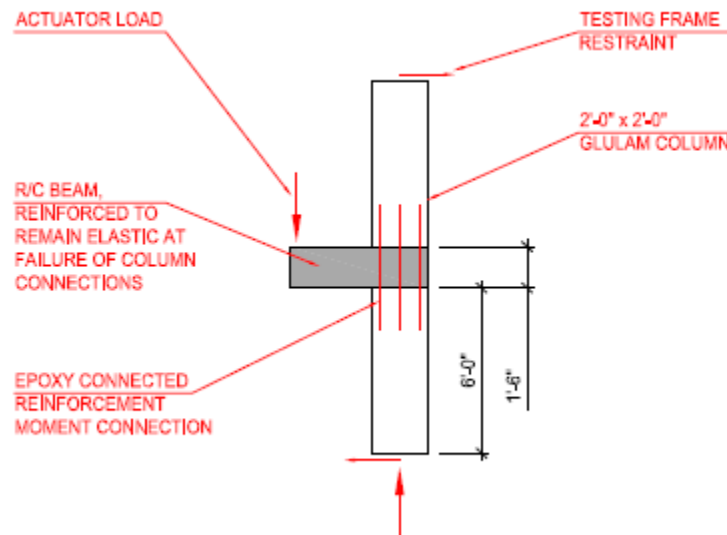

Figure A2-3: Column Moment Connection Test

### A2.4: Full Scale System Mockup

The total system constructability and behavior must be verified. A full scale mockup of a single floor with a minimum of 3 typical bays (3x16ft=48ft by 30ft in plan) is recommended. The construction of the mockup should validate the design tolerances of the details. The mockup is to be tested for dynamic behavior, vibrations, acoustics, shrinkage/volume changes, and durability. The mockup is to be loaded with expected gravity loads and monitored for long term deflection behavior. After determination of long term behavior, the mockup is to be loaded to full service and ultimate loads. Fire testing and moisture/durability testing of the mockup at load should also be considered.

### A2.5: Fire Resistance Testing

A fire engineer should review this report and determine the necessary fire testing program. Fire and loading tests should be combined and performed by a single laboratory where practical.

## Appendix 3: Additional Connection Details

The connection details documented in the main body of the report show one potential way to achieve the design behavior of the proposed CJTF system. The design behavior could be achieved with other details as shown in the figures below. These additional details should be studied as part of the physical testing program as recommended in Appendix 2.

### Composite Plank Details

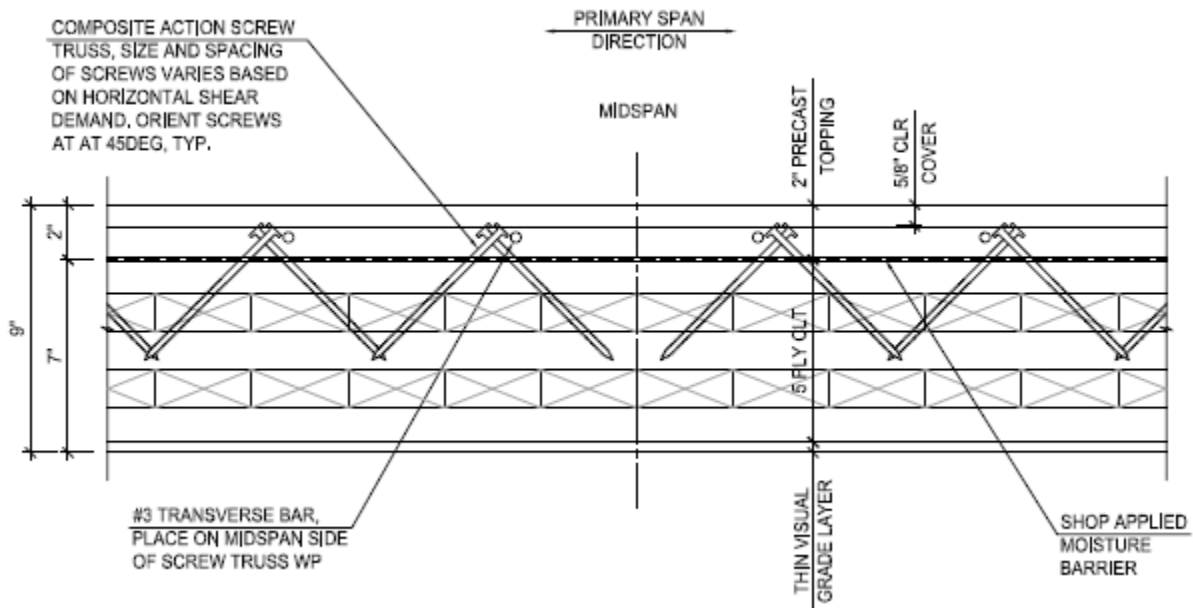

**Figure A3-1a: Composite Plank with Screw Connectors**

Notes: This composite plank approach uses diagonally oriented screws to transfer horizontal shear. The transverse reinforcing in the topping slab is placed on the midspan side of the screws and below the heads of the screws. This is done with the goal to enhance the connection between the screws and the topping slab.

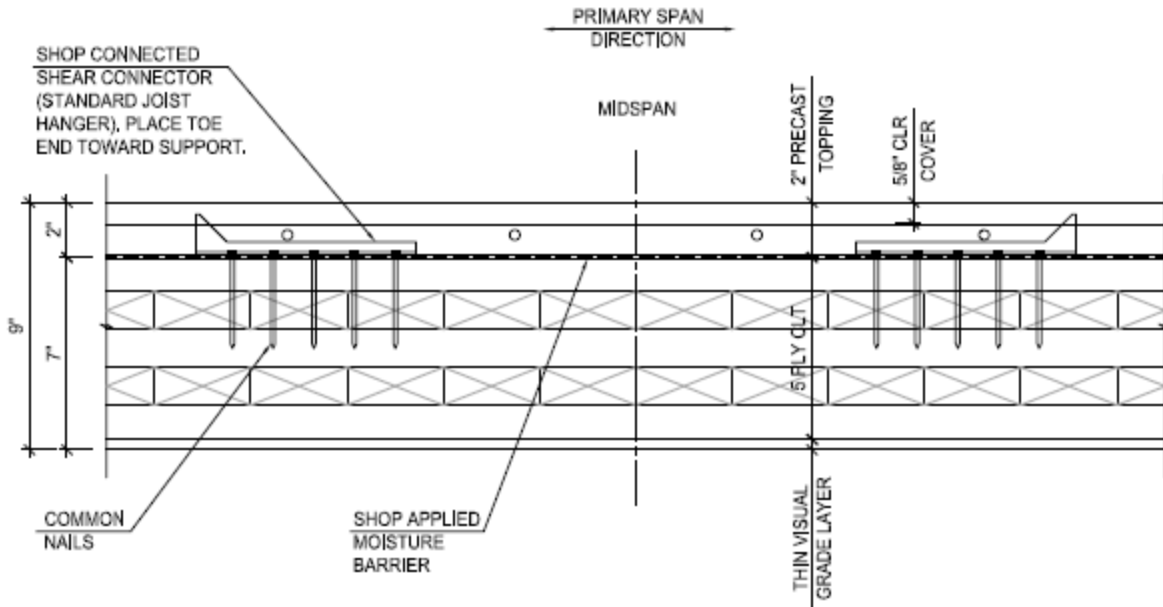

**Figure A3-1b: Composite Plank with Joist Hangers**

Notes: This composite plank approach uses standard wood framing joist hangers and common nails to transfer horizontal shear. The hangers are oriented with the toe toward the support so that the horizontal shear forces act in the same direction as gravity in a standard joist connection.

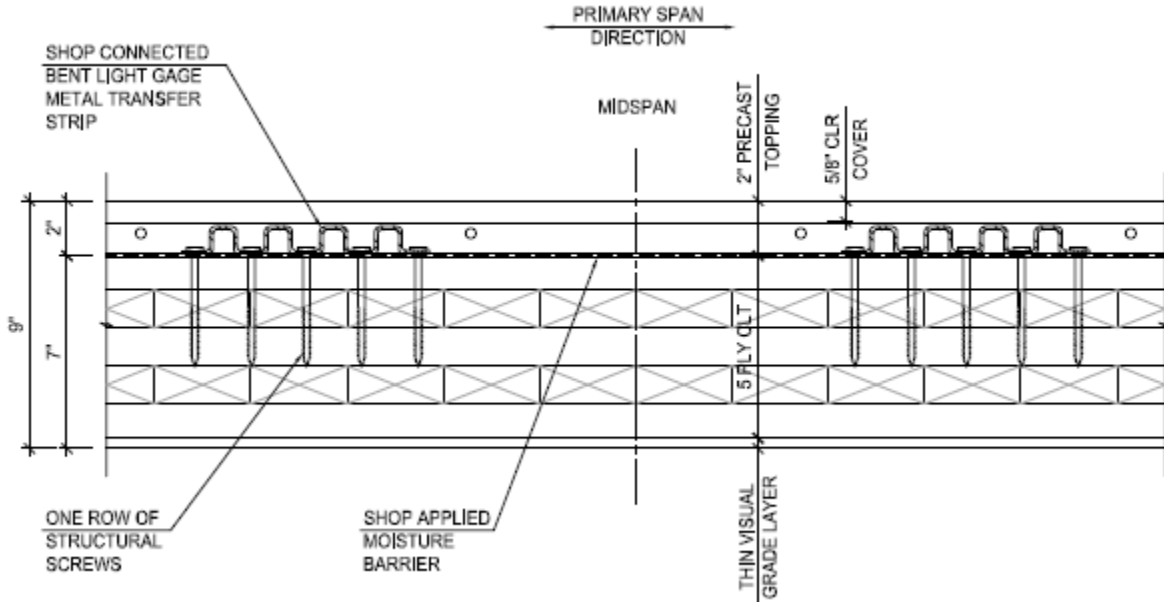

**Figure A3-1c: Composite Plank with Bent Light Gage Metal Strips**

Notes: This composite plank approach uses a bent light gage metal similar to a corrugated deck to transfer horizontal shear between the concrete topping slab and structural screws connected to the CLT plank. The shear connectors also serve as chairs for reinforcing in the topping slab. Reinforcing could also be welded to the bent gage metal to enhance the connection in negative bending regions.

## Transverse Span Detail

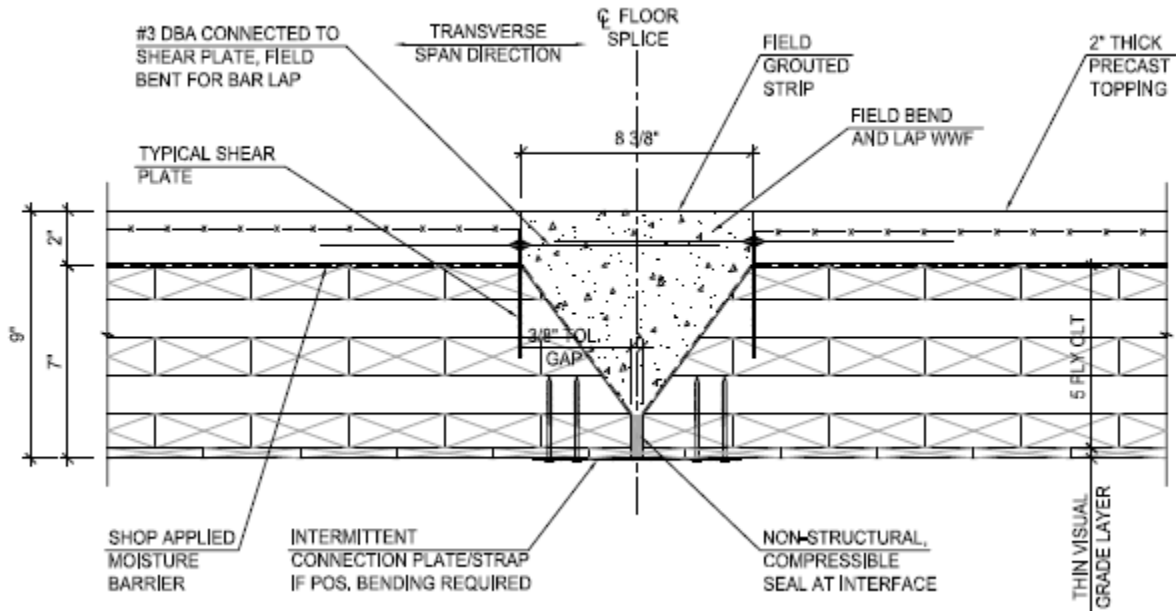

**Figure A3-2: Transverse Span Plank to Plank Connection**

Notes: This detail is a more robust plank to plank connection. This detail could be used in situations where 2-way behavior of the system is required and plank splices cannot be located near inflection points as was done in the study geometry.

## Plank End Connection Details

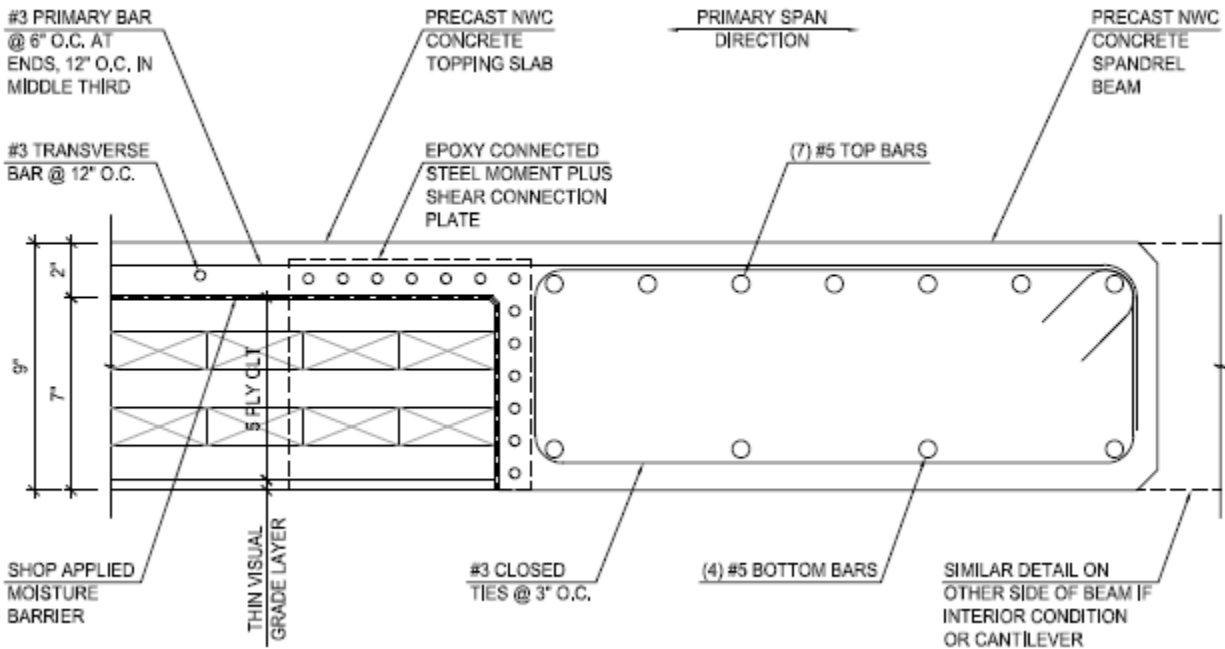

**Figure A3-3a: Plank End Connection A**

Notes: This detail achieves a flat soffit condition by pre-casting the composite plank and spandrel beam together off-site. The end connection of the plank must transfer both shear and moment to the spandrel element. The splice of the spandrel would follow detail A3-5.



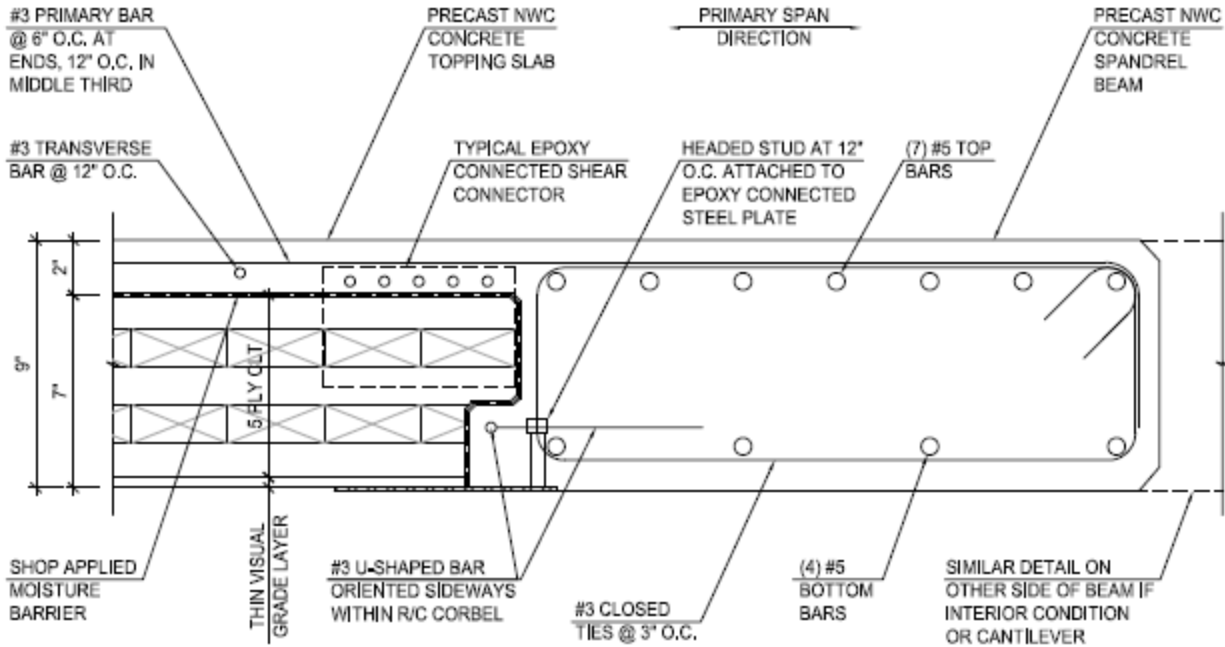

**Figure A3-3b: Plank End Connection B**

Notes: This detail achieves a flat soffit condition similar to detail A3-3a but differs in that shear at the end of the composite plank is transferred by bearing on a concealed corbel. This approach relies less on epoxy and may be more fire resistant. The compression component of end moment is transferred similar to the base detail.

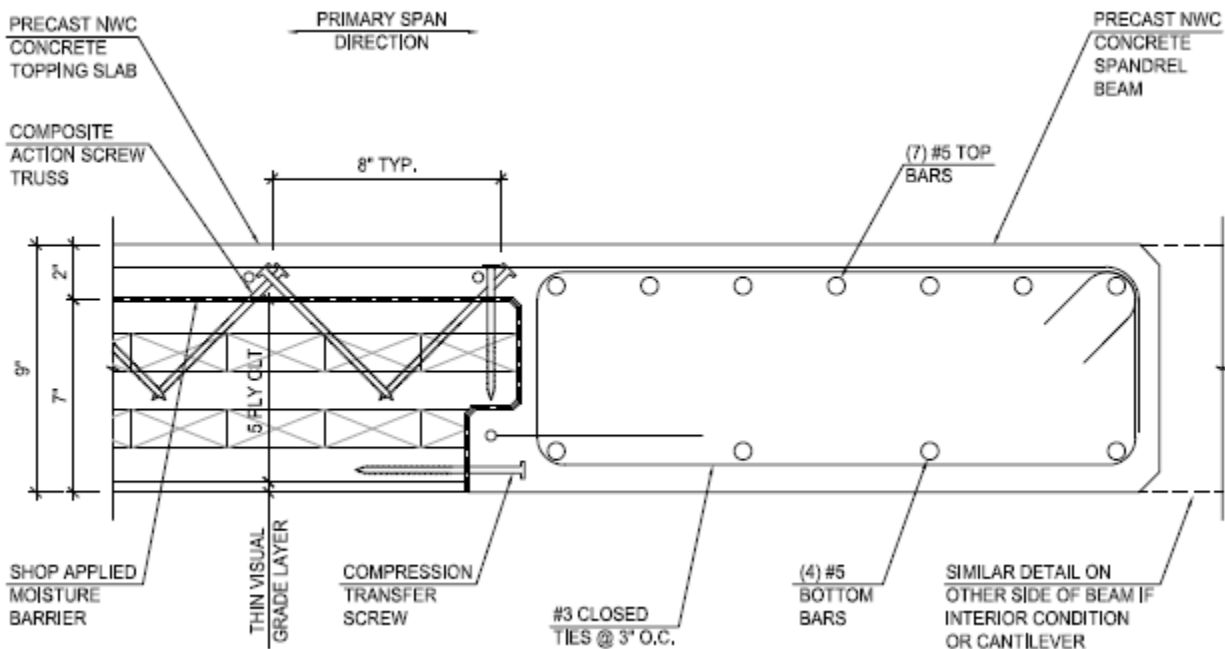

**Figure A3-3c: Plank End Connection C**

Notes: This detail follows the same logic as A3-3b without the use of any epoxy. Compression transfer screws are provided to avoid stiffness losses due to shrinkage in the CLT or precast spandrel beam.

## Composite Heavy Timber System Details

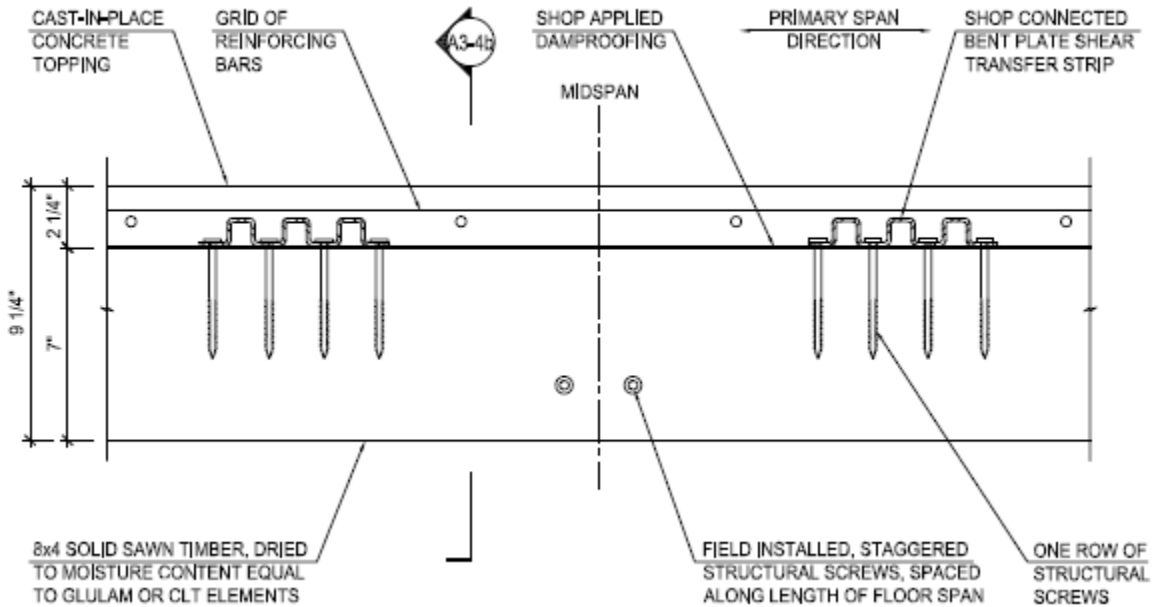

**Figure A3-4a: Composite Heavy Timber System – Primary Span**

Notes: This floor system consists of 4" nominal width heavy timbers with a composite concrete topping slab. This type of system might be possible since the topping slab provides the in-plan dimensional stability that would otherwise be provided by the cross-lamination of CLT. The topping could be either precast or cast-in-place.

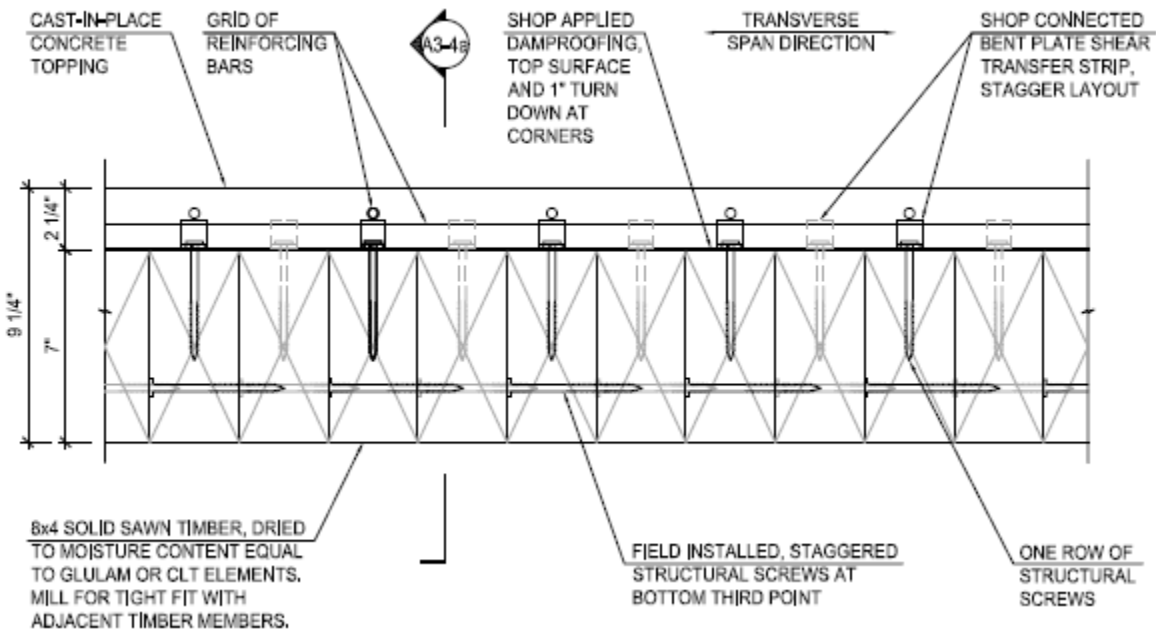

**Figure A3-4b: Composite Heavy Timber System – Transverse Span**

Notes: A nominal number of screws are provided in the transverse direction to force the heavy timbers to deflect as a group and to provide robustness. The spacing of the transverse screws along the length of the floor is expected to be 4ft.

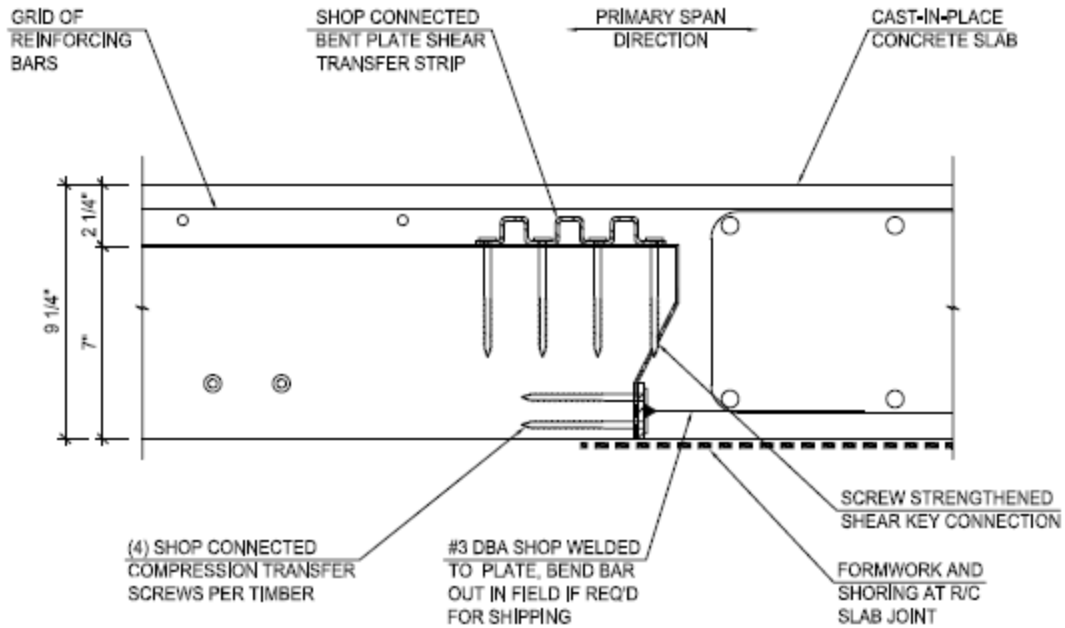

**Figure A3-4c: Composite Heavy Timber System – End Connection**

Notes: The end connection of the heavy timber system would utilize a concealed corbel approach similar to Figure A3-3c. The corbel is inclined to avoid shear splitting of the timber. The horizontal shear connector at this zone is to be designed to help resist vertical dimensional changes which might cause splitting. Compression is transferred by a developed deformed bar anchor, welded to a steel plate, and screwed to the heavy timber. This connection is intended to transfer compression regardless of shrinkage that might occur in either the timber or concrete. The deformed bar anchor could be installed with a 90 degree bend and field bent straight to improve shipping. The concrete slab and beam could be either precast or cast-in-place.

## Spandrel Beam Splice Detail

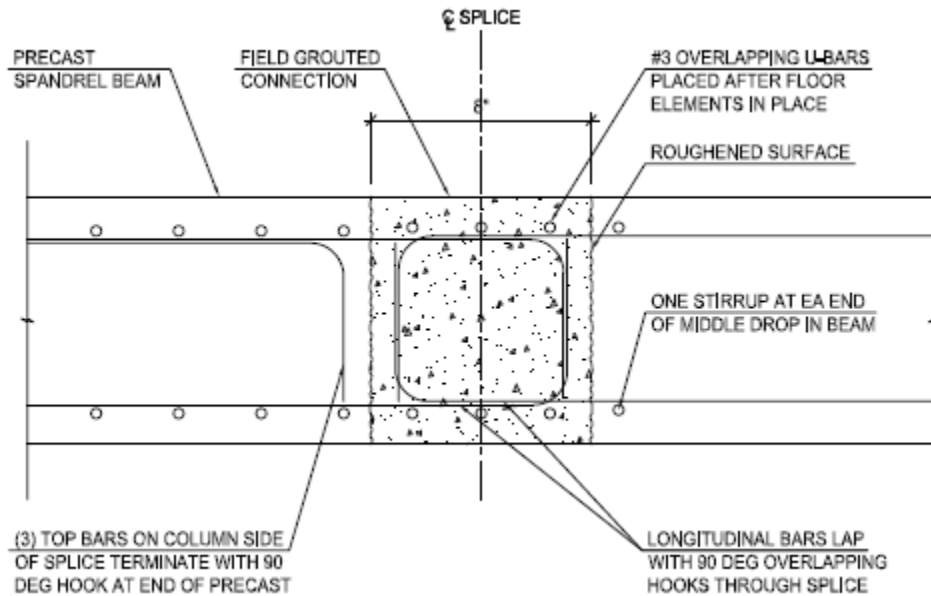

**Figure A3-5: Composite Heavy Timber System – End Connection**

Notes: This spandrel beam splice is intended to be more economical than the base detail shown in the main body of the report. The connection splices hooked bars through a small grouted segment. The splice length is insufficient to develop the full capacities of the bars and therefore the splice must be located near inflection points of the beams, as is done in the study geometry shown in this report.

Column Connection Details

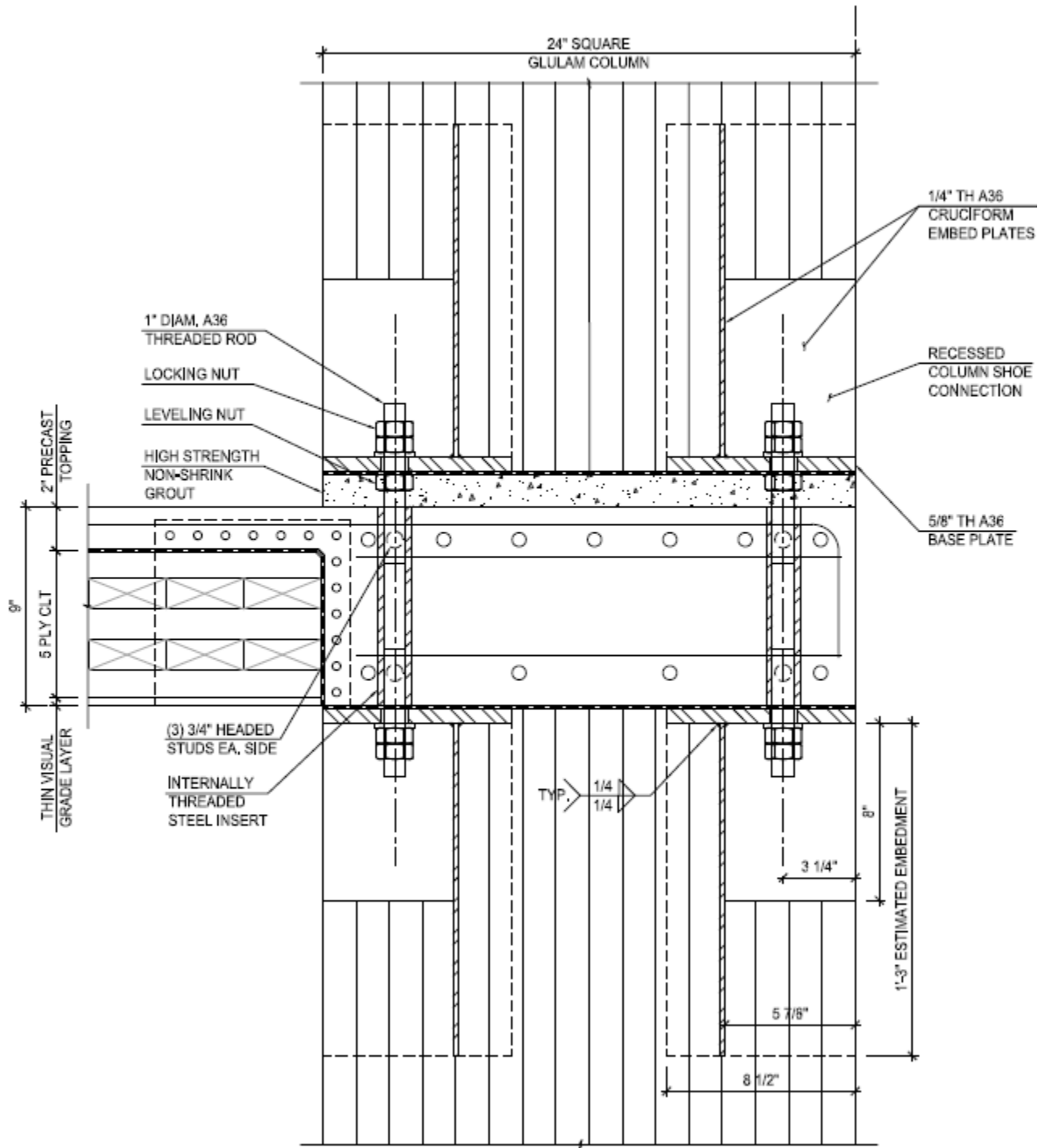

**Figure A3-6a: Column Connection A**

Notes: This column connection detail is paired with Figure A3-3a. The column splice must occur above and below the floor lines if the spandrel beam is precast with the composite floor planks. This detail achieves that requirement with epoxy connected column shoes. Threaded inserts are provided in the spandrel beam to connect to the column rods which may improve the shipping and handling of the floor plank / spandrel beam unit.

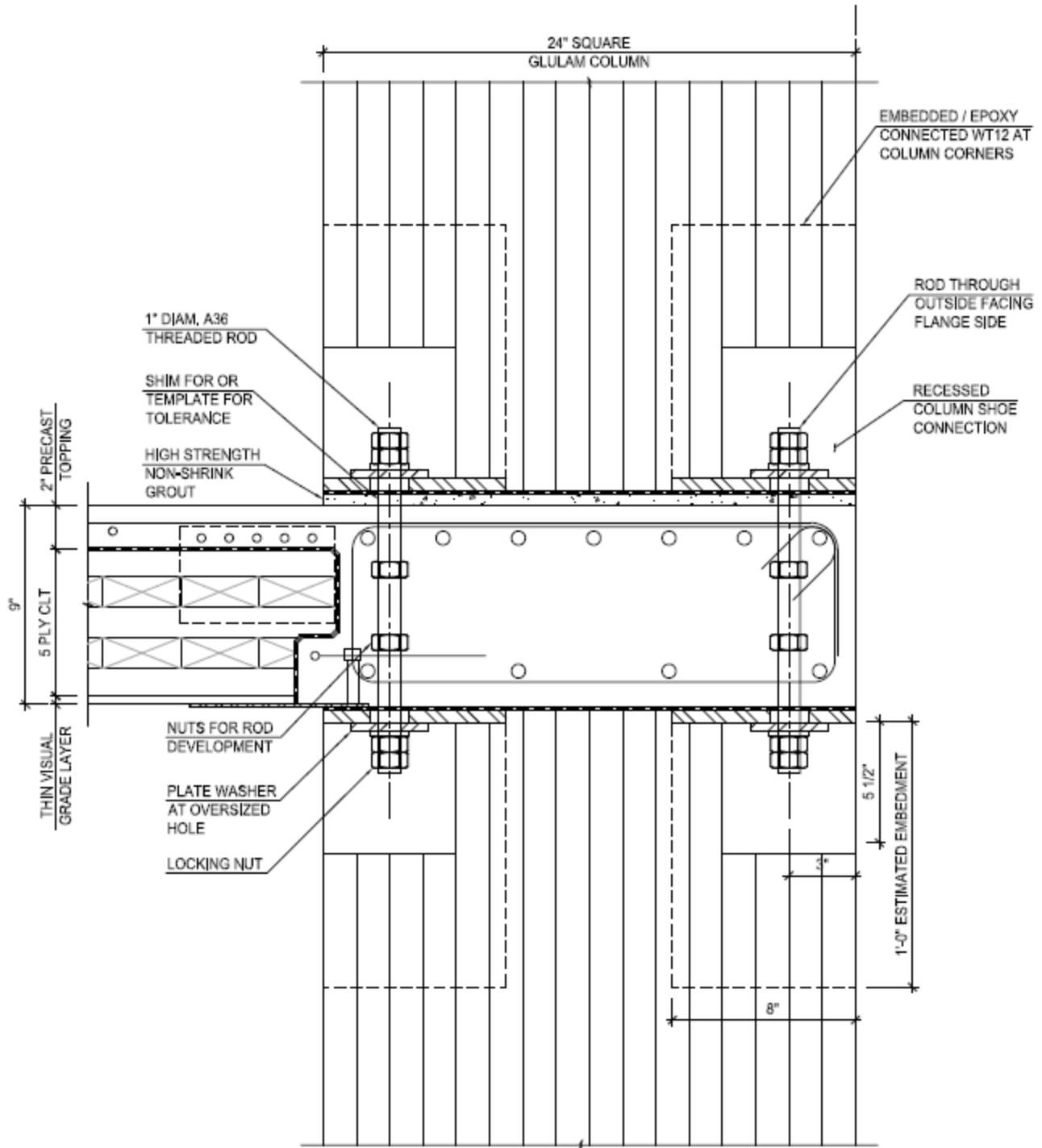

**Figure A3-6b: Column Connection B**

Notes: This column connection detail is paired with Figure A3-3b but could also apply to Figure A3-3a. This connection uses WT steel shapes as the column shoes instead of fabricated steel shoes as it is thought to be more economical. The threaded rod connections shown in this detail are embedded in the spandrel element.

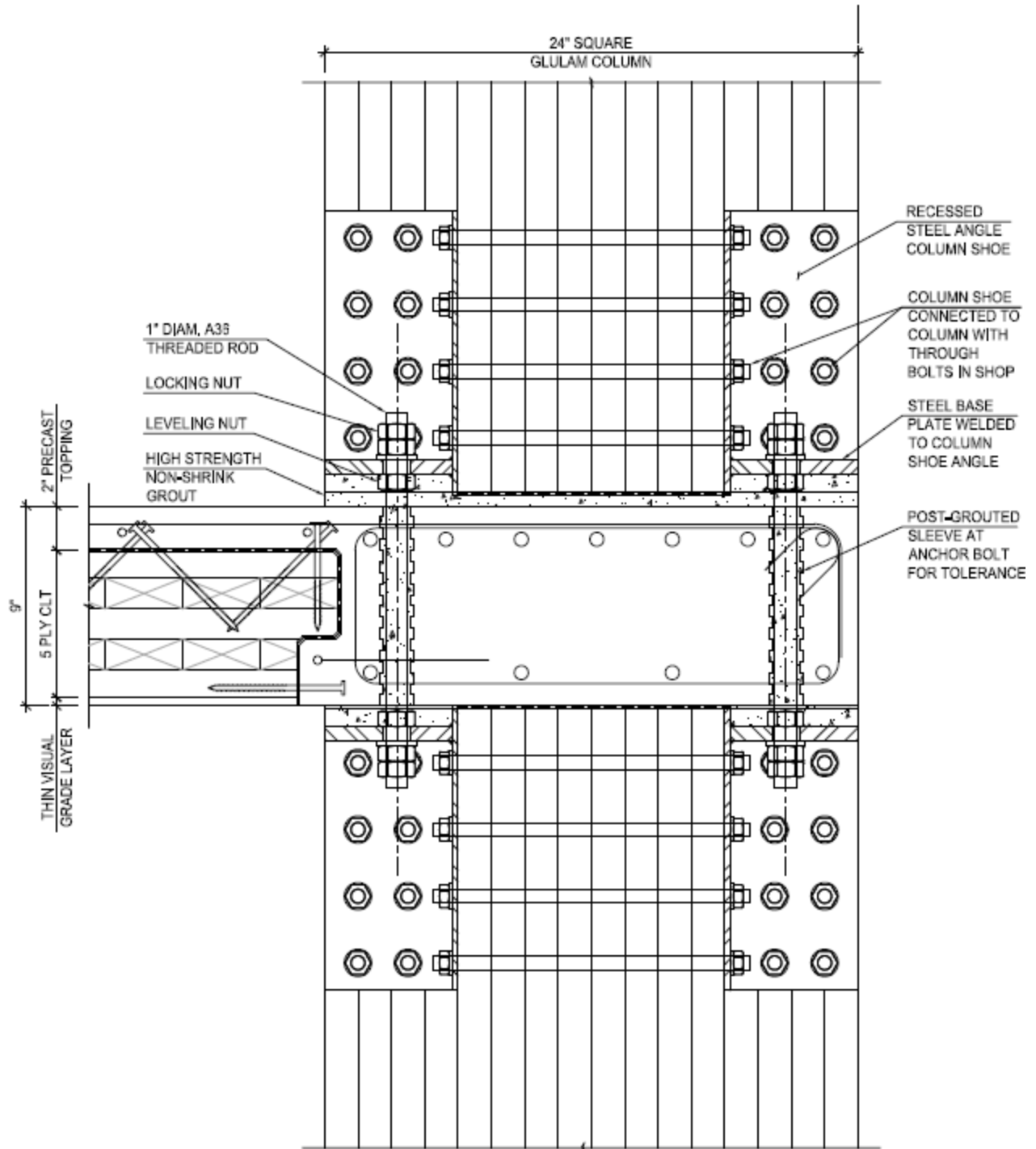

**Figure A3-6b: Column Connection C**

Notes: This column connection detail is paired with Figures A3-3c but could also apply to both Figure A3-3a and A3-3b. This connection eliminates the use of epoxy by using steel angles connected to the columns with through bolts. The threaded rods connecting the column to the spandrel beam are post-grouted for ease of shipping and tolerance.

## References

- [1] American Society of Civil Engineers, ASCE. (2010). "Minimum Design Loads for Buildings and Other Structures." ASCE/SEI 7-10. Reston, VA.
- [2] American Concrete Institute, ACI. (2008). "Building Code Requirements for Structural Concrete (ACI 318-08) and Commentary." ACI 318-08. Farmington Hills, MI.
- [3] Karacabeyli, E and Douglas, B., eds. (2013). *Cross Laminated Timber (CLT) Handbook*. U.S. Department of Agriculture, Forest Products Laboratory, Binational Softwood Lumber Council. Pointe-Claire, QC.
- [4] Murray, T.M., Allen, D.E. and Ungar E.E. (1997). "Floor Vibrations Due to Human Activity." *AISC Steel Design Guide #11*, American Institute of Steel Construction, Chicago, IL.
- [5] Gerber, C., Crews, K., Foscoliano, M., and Agus, F., (2010). "Development of Timber Concrete Composite Flooring in Australia and New Zealand." *Proc. World Conference on Timber Engineering*. 1-8.
- [6] Sturzenbecher, R., Hofstetter, K., and Eberhardsteiner, J., (2010). "Structural design of Cross Laminated Timber (CLT) by advanced plate theories." *Composites Science and Technology*. 70, 1368-1379.
- [7] Schultz, J.A. and Johnson, B.M. "Evaluation of North American Vibration Standards for Mass-Timber Floors." Proceedings, IMAC – XXII: A Conference on Structural Dynamics, February 3-6, 2013. Society for Experimental Mechanics, Bethel, CT. (2013).
- [8] American Wood Council, AWC. (2012). "National Design Standard for Wood Construction ASD/LRFD" Leesburg, VA.
- [9] APA – The Engineered Wood Association. (2011). "Standard for Performance-Related Cross-Laminated Timber." ANSI/APA PRG320-2011. Tacoma, WA.
- [10] Manaridis, A. (2010). "Evaluation of Timber-Concrete Composite Floors". Lund Institute of Technology, Sweden.